

## Faz butaca

por Ramón Esteve

La colección Faz es un testimonio de la excelencia y la visión única de Vondom, plasmada por Ramón Esteve. Desde su lanzamiento, esta serie ha cautivado a quienes buscan piezas que no solo marquen la diferencia, sino que inviten a disfrutar del entorno con una mirada contemporánea y relajada. Con un diseño modular que da libertad para crear, Faz transforma los ambientes con su combinación única de materia y luz, creando una atmósfera envolvente y exclusiva.



## Info

---

### Descripción

Fabricado con resina de polietileno mediante moldeo rotacional con doble pared. 100% Reciclable. Apto para exterior e interior. Disponible en varios acabados.

Peso: 24.04 Kg

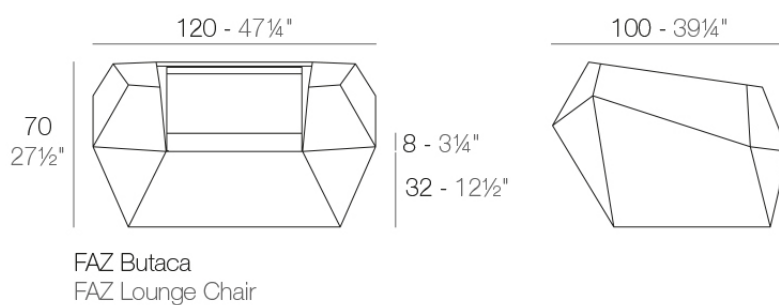

## Acabados

---

### acabados

---

#### BASIC

Ref. 54001

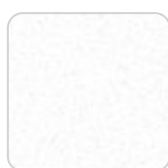

white 2001



ecru 2003



tortora 2004

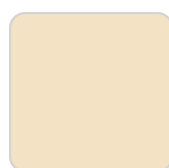

cream 2017



camel 2020

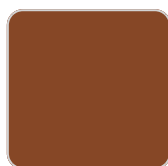

clay 2022



garnet 2015



brown 2008



green 2016



blue 2018



gray 2005



anthracite 2006



black 2002



ecru granite



cream granite

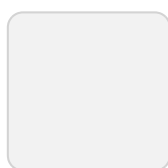

ice 2101

Resina de polietileno acabado mate.

#### LACADO

Ref. 54001F

# VONDONOM



white 3101



ecru 3103



tortora 3104



cream 3117



garnet 3113



brown 3125



green 3116



blue 3118



gray 3105



anthracite 3106



black 3102

Resina de polietileno con un acabado lacado brillo.

## luz

---

LED BLANCO

Ref. 54001W



ice 2101

Con iluminación interior de color blanco mediante tecnología LED. Solo disponible en acabado hielo mate.

LED RGBW

Ref. 54001L



ice 2101

Con iluminación interior mediante tecnología LED RGBW y mando a distancia para cambiar de color. Solo disponible en acabado hielo mate. Acompañado de un mando a distancia para el cambio de color\* por selección o de forma automática.

## LED RGBW DMX

Ref. 54001D

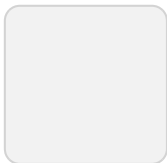

ice 2101

Con iluminación interior mediante tecnología LED RGBW y mando a distancia para cambiar de color. Controlado también por DMX-1024 (wireless). Solo disponible en acabado hielo mate, permitiendo la comunicación entre uno o múltiples productos simultáneamente mediante el transmisor DMX (no incluido). Hay dos opciones para seleccionar. Professional XLR DMX y Home WIFI DMX.

## LED RGBW BATERIA

Ref. 54001Y

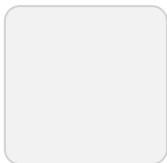

ice 2101

Con iluminación interior mediante tecnología LED RGBW, alimentado por una batería. Se incluye mando a distancia para cambiar de color y cargador. Solo disponible en acabado hielo mate.

## LED RGBW DMX BATERIA Ref. 54001DY



ice 2101

Con iluminación interior mediante tecnología LED RGBW, alimentado por una batería. Incluye mando a distancia para cambiar de color. Controlado también por DMX-1024 (wireless). Solo disponible en acabado hielo mate. permitiendo la comunicación entre uno o multiples productos simultaneamente mediante el transmisor DMX (no incluido). Hay dos opciones para seleccionar. Professional XLR DMX y Home WIFI DMX.

## tejidos

---

### GETARIA Ref. 54001CCO



white 10041 getaria



niord 10015 getaria



moon 10040 getaria



dune 10009 getaria



brown 10050 getaria



terra 10039 getaria



granite 10008 getaria



tortora 10048 getaria



camel 10033 getaria



oasis 10007 getaria

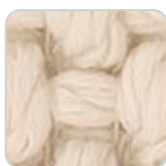

cream 10047 getaria

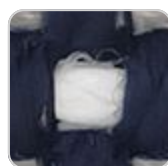

gallant 10025 getaria

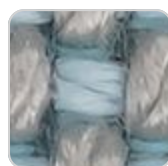

pearl 10006 getaria

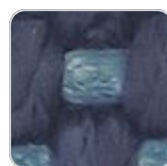

blue 10024 getaria



garnet 10046 getaria

# VONDOM



oversea 10002 getaria



ocean 10023 getaria



black 10044 getaria



emerald 10016  
getaria



anthracite 10043  
getaria

Group 2. Tejido premium 1005 acrilico, con una alta densidad, presente en una amplia gama de colores.

## BAIONA

Ref. 54001CCO



jade 10109 baiona

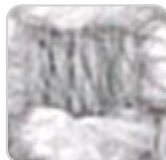

ecru 10101 baiona

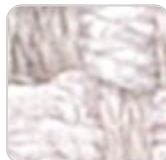

white 10100 baiona



brown 10108 baiona

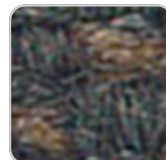

black 10114 baiona



garnet 10107 baiona



gray 10113 baiona



clay 10106 baiona

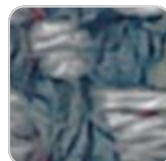

blue 10112 baiona

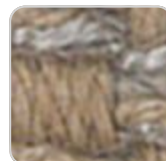

camel 10104 baiona

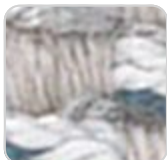

ocean 10111 baiona

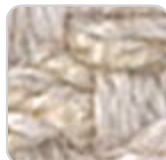

cream 10103 baiona

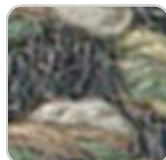

green 10110 baiona

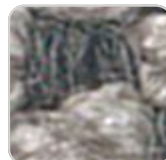

tortora 10102 baiona

Group 1C. Tejido 100% acrilico de alta densidad, que aporta sensacion de solidez y un patron irregular que añade un toque artesanal.

## CALELLA

Ref. 54001CCO

# VONDOM



tortora 10122 calella



anthracite 10129 calella

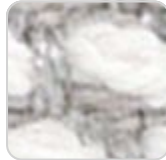

ecru 10121 calella

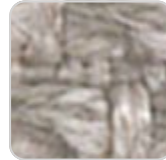

gray 10128 calella

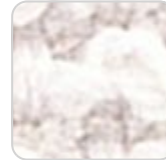

white 10120 calella



blue 10127 calella



jade 10126 calella



clay 10125 calella



mustard 10124 calella

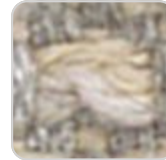

cream 10123 calella

Group 1C. Tejido 100% acrilico libre de PFAS, con una textura rica e inusual y una suavidad excepcional, que mejora la comodidad de los muebles.

## FISTERRA

Ref. 54001CCO



cream 10132 fisterra



white 10130 fisterra



ecru 10131 fisterra



tortora 10135 fisterra



camel 10134 fisterra



peach 10146 fisterra



clay 10137 fisterra



garnet 10138 fisterra

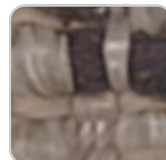

brown 10136 fisterra

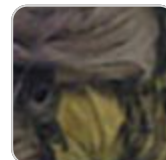

olive 10145 fisterra



jade 10139 fisterra

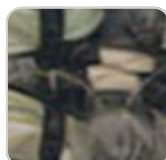

green 10140 fisterra



ocean 10141 fisterra



blue 10142 fisterra



gray 10143 fisterra



anthracite 10144 fisterra



black 10147 fisterra



# VONDOM

Group 1C. Tejido 100% acrilico, con un patron irregular jaspeado muy distintivo y un tacto suave.

## PORTONOVO Ref. 54001CCO



garnet 10157  
portonovo



black 10165  
portonovo



clay 10156 portonovo



anthracite 10164  
portonovo



mustard 10155  
portonovo



gray 10163 portonovo



camel 10154  
portonovo



blue 10162 portonovo



cream 10153  
portonovo



ocean 10161  
portonovo



green 10160  
portonovo



tortora 10152  
portonovo



jade 10159 portonovo

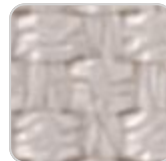

ecru 10151 portonovo

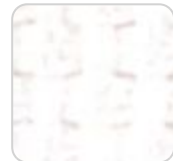

white 10150  
portonovo

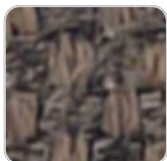

brown 10158  
portonovo

Group 1A. Tejido 100% acrilico, con diseño liso y sencillo, que se adapta a cualquier estilo.

## ZUMAIA Ref. 54001CCO

# VONDOM



white 10200 zumaia



black 10205 zumaia



green 10204 zumaia



blue 10203 zumaia



garnet 10202 zumaia



cream 10201 zumaia

Group 2. Tejido elegante 100% acrilico, con un rizo suave, agradable al tacto y una combinacion de colores distintiva.

## SUANCES

Ref. 54001CCO



tortora 10302 suances



green 10310 suances



jade 10309 suances



ecru 10301 suances



olive 10317 suances



brown 10308 suances

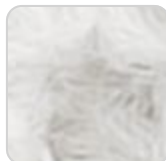

white 10300 suances



peach 10316 suances

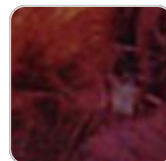

garnet 10307 suances

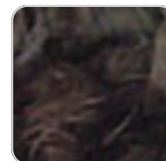

black 10315 suances



clay 10306 suances



anthracite 10314  
suances



mustard 10305  
suances

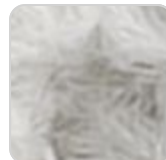

gray 10313 suances

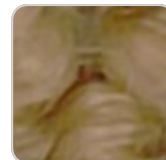

camel 10304 suances



blue 10312 suances

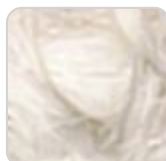

cream 10303 suances



ocean 10311 suances

Group 2. Tejido de rizo, destaca por su calidez y suavidad, con colores

# VONDOM

combinados que añaden profundidad y elegancia.

## RIBADEO

Ref. 54001CCO



mint 10337 ribadeo



brown 10328 ribadeo



white 10320 ribadeo

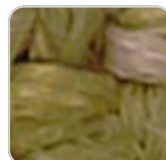

olive 10336 ribadeo



garnet 10327 ribadeo



peach 10335 ribadeo



clay 10326 ribadeo

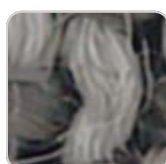

anthracite 10334  
ribadeo

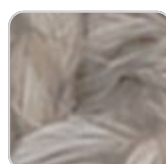

gray 10333 ribadeo



mustard 10325  
ribadeo

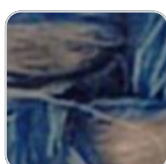

blue 10332 ribadeo



camel 10324 ribadeo



ocean 10331 ribadeo

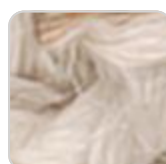

cream 10323 ribadeo



green 10330 ribadeo



tortora 10322 ribadeo



jade 10329 ribadeo



ecru 10321 ribadeo

Group 2. Suave tejido que presenta hilos jaspeados de diferentes grosores que crean una textura rica y visualmente interesante. Su apariencia de lino añade un toque de estilo natural.

## LOURO

Ref. 54001CCO

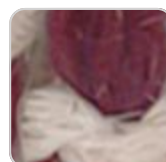
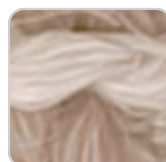
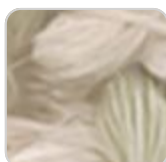

# VONDOM

jade 10349 louro



anthracite 10354 louro

olive 10356 louro



clay 10346 louro

brown 10348 louro



gray 10353 louro

peach 10355 louro



mustard 10345 louro

garnet 10347 louro

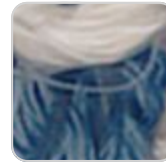

blue 10352 louro



camel 10344 louro



cream 10343 louro



ocean 10351 louro



tortora 10342 louro



green 10350 louro

Group 2. Tejido suave y versatil que presenta un color neutro de base que facilita su integracion con diversos colores y tejidos.

## ALTEA

Ref. 54001CCO



tortora 1102 altea



white 1100 altea



camel 1120 altea



clay 1122 altea



garnet 1106 altea



brown 1104 altea



jade 1125 altea



ocean 1123 altea



gray 1101 altea



anthracite 1124 altea



black 1105 altea

Group 1A. Tejido suave para exteriores, con textura similar a la piel.

## AROUSA

Ref. 54001CCO

# VONDOM



tortora 1209 arousa



camel 1230 arousa



clay 1231 arousa



brown 1214 arousa

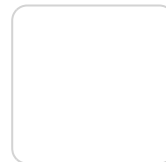

jade 1235 arousa



gray 1208 arousa



anthracite 1210  
arousa

Group 1B. Tejido suave para exteriores, con acabado brillante.

## Ambients

---

