

## Vela puff 80x80x40

por Ramón Esteve

La colección Vela, diseñada por Ramón Esteve para Vondom, ofrece una amplia gama de muebles de exterior y maceteros que combinan el confort y la calidez de los muebles de interior. Con un diseño que equilibra proporciones y líneas geométricas, Vela transforma cualquier espacio en un refugio acogedor y elegante.



## Info

---

### Descripción

Fabricado con resina de polietileno mediante moldeo rotacional con doble pared. 100% Reciclable. Apto para exterior e interior. Disponible en varios acabados.

Peso: 12.38 Kg

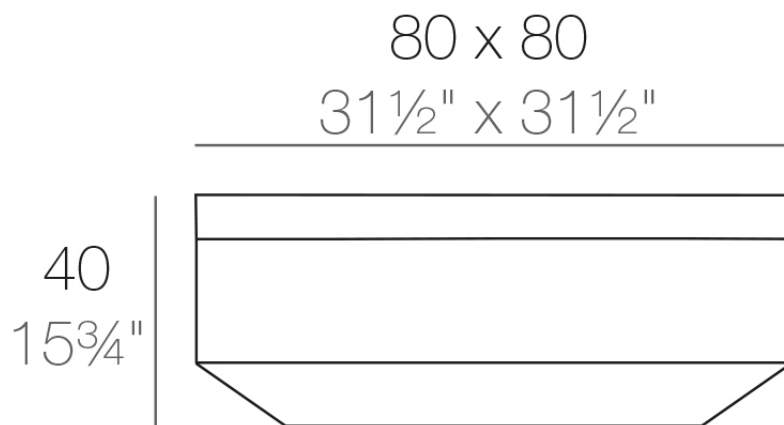

VELA CHILL Puff 80x80

VELA CHILL Ottoman

31½"x31½"

## Acabados

---

### acabados

---

Basic

Ref. 54071



white 2001



black 2002



ecru 2003



tortora 2004



gray 2005



anthracite 2006



brown 2008



garnet 2015



green 2016



cream 2017



blue 2018



camel 2020



clay 2022



ecru granite



cream granite



ice 2101

Resina de polietileno acabado mate.

Lacquered

Ref. 54071F



white 3101



black 3102



ecru 3103



tortora 3104



gray 3105



anthracite 3106



garnet 3113



green 3116



cream 3117



blue 3118



brown 3125

Resina de polietileno con un acabado lacado brillo.

## luz

---

LED RGBW – Battery

Ref. 54071Y

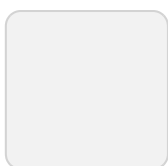

ice 2101

Con iluminación interior mediante tecnología LED RGBW, alimentado por una batería. Se incluye mando a distancia para cambiar de color y cargador. Solo disponible en acabado hielo mate.

LED RGBW DMX – Battery

Ref. 54071DY



ice 2101

Con iluminación interior mediante tecnología LED RGBW, alimentado por una batería. Incluye mando a distancia para cambiar de color. Controlado también por DMX-1024 (wireless). Solo disponible en acabado hielo mate. permitiendo la comunicación entre uno o multiples productos simultaneamente mediante el transmisor DMX (no incluido). Hay dos opciones para seleccionar. Professional XLR DMX y Home WIFI DMX.

## tejidos

---

### BAIONA

Ref. 53028CO



brown 10108 baiona



garnet 10107 baiona



clay 10106 baiona

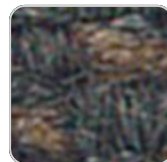

black 10114 baiona



gray 10113 baiona



camel 10104 baiona



blue 10112 baiona

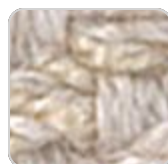

cream 10103 baiona

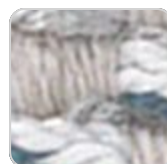

ocean 10111 baiona

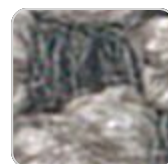

tortora 10102 baiona



green 10110 baiona

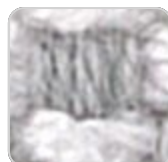

ecru 10101 baiona

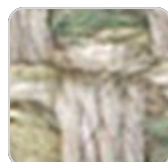

jade 10109 baiona

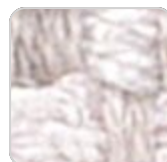

white 10100 baiona

Group 1C. Tejido 100% acrilico de alta densidad, que aporta sensacion de solidez y un patron irregular que añade un toque artesanal.

# VONDOM

## CALELLA

Ref. 53028CO



anthracite 10129  
calella



ecru 10121 calella



gray 10128 calella



white 10120 calella



blue 10127 calella



jade 10126 calella



clay 10125 calella



mustard 10124 calella



cream 10123 calella



tortora 10122 calella

Group 1C. Tejido 100% acrílico libre de PFAS, con una textura rica e inusual y una suavidad excepcional, que mejora la comodidad de los muebles.

## FISTERRA

Ref. 53028CO



cream 10132 fisterra



white 10130 fisterra



ecru 10131 fisterra



tortora 10135 fisterra



camel 10134 fisterra



peach 10146 fisterra



clay 10137 fisterra

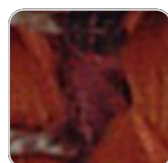

garnet 10138 fisterra

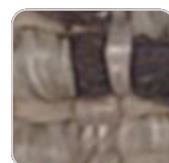

brown 10136 fisterra

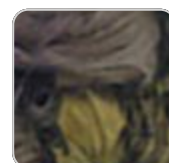

olive 10145 fisterra



jade 10139 fisterra



green 10140 fisterra



ocean 10141 fisterra



blue 10142 fisterra



gray 10143 fisterra



# VONDOM

anthracite 10144  
fisterra

black 10147 fisterra

Group 1C. Tejido 100% acrilico, con un patron irregular jaspeado muy distintivo y un tacto suave.

## PORTONOVO Ref. 53028CO



anthracite 10164  
portonovo

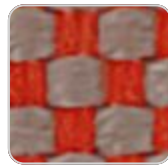

clay 10156 portonovo



gray 10163 portonovo



mustard 10155  
portonovo



blue 10162 portonovo



camel 10154  
portonovo



ocean 10161  
portonovo



cream 10153  
portonovo

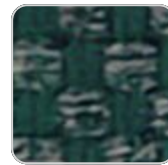

green 10160  
portonovo



tortora 10152  
portonovo



jade 10159 portonovo



ecru 10151 portonovo

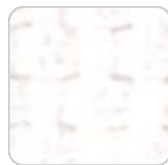

white 10150  
portonovo

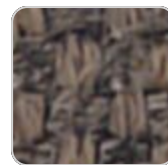

brown 10158  
portonovo



black 10165  
portonovo



garnet 10157  
portonovo

Group 1A. Tejido 100% acrilico, con diseño liso y sencillo, que se adapta a cualquier estilo.

## ALTEA Ref. 53028CO

# VONDOM



tortora 1102 altea



white 1100 altea



camel 1120 altea



clay 1122 altea



garnet 1106 altea



brown 1104 altea



jade 1125 altea



ocean 1123 altea



gray 1101 altea



anthracite 1124 altea



black 1105 altea

Group 1A. Tejido suave para exteriores, con textura similar a la piel.

## AROUSA Ref. 53028CO



tortora 1209 arousa



camel 1230 arousa



clay 1231 arousa



brown 1214 arousa

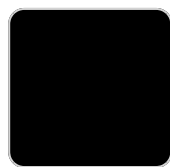

jade 1235 arousa



gray 1208 arousa



anthracite 1210  
arousa

Group 1B. Tejido suave para exteriores, con acabado brillante.

