

## Frame sofá

por Ramón Esteve

La colección outdoor Frame de Vondom, diseñada por Ramón Esteve, nace de la generación de formas serenas y atemporales valiéndose del marco como geometría elemental. Motivado por las infinitas posibilidades que nos ofrece el material, empleando una tecnología avanzada, se exploran los límites de éste.



## Info

---

### Descripción

Fabricado con resina de polietileno mediante moldeo rotacional con doble pared. 100% Reciclable. Apto para exterior e interior. Disponible en varios acabados.

Peso: 37 Kg

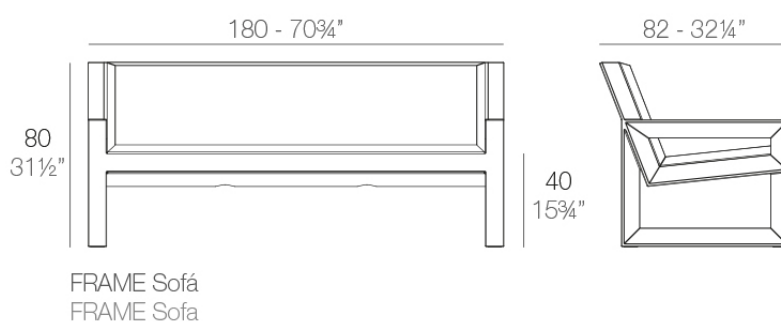

## Acabados

---

### acabados

---

Basic

Ref. 54095



white 2001



black 2002



ecru 2003



tortora 2004



gray 2005



anthracite 2006



brown 2008



garnet 2015



green 2016



cream 2017



blue 2018



camel 2020



clay 2022



ecru granite



cream granite



ice 2101

Resina de polietileno acabado mate.

### tejidos

---

BAIONA

Ref. 54095CO

# VONDOM



gray 10113 baiona



camel 10104 baiona



cream 10103 baiona



blue 10112 baiona



tortora 10102 baiona



ocean 10111 baiona



ecru 10101 baiona



green 10110 baiona

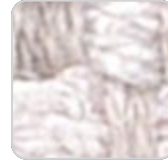

white 10100 baiona

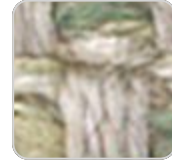

jade 10109 baiona



brown 10108 baiona



garnet 10107 baiona



black 10114 baiona



clay 10106 baiona

Group 1C. Tejido 100% acrilico de alta densidad, que aporta sensacion de solidez y un patron irregular que añade un toque artesanal.

## CALELLA

Ref. 54095CO



jade 10126 calella



clay 10125 calella



mustard 10124 calella

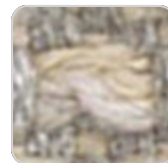

cream 10123 calella



tortora 10122 calella



anthracite 10129  
calella

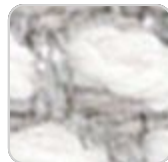

ecru 10121 calella

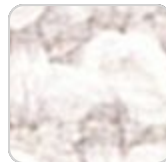

white 10120 calella

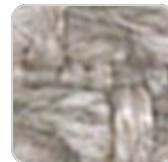

gray 10128 calella



blue 10127 calella

Group 1C. Tejido 100% acrilico libre de PFAS, con una textura rica e inusual y una suavidad excepcional, que mejora la comodidad de los muebles.

## FISTERRA

# VONDOM

Ref. 54095CO



cream 10132 fisterra



white 10130 fisterra



ecru 10131 fisterra



tortora 10135 fisterra



camel 10134 fisterra



peach 10146 fisterra



clay 10137 fisterra



garnet 10138 fisterra



brown 10136 fisterra

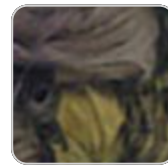

olive 10145 fisterra



jade 10139 fisterra



green 10140 fisterra



ocean 10141 fisterra



blue 10142 fisterra



gray 10143 fisterra



anthracite 10144  
fisterra



black 10147 fisterra

Group 1C. Tejido 100% acrilico, con un patron irregular jaspeado muy distintivo y un tacto suave.

## PORTONOVO

Ref. 54095CO



ocean 10161  
portonovo



cream 10153  
portonovo



green 10160  
portonovo



tortora 10152  
portonovo



jade 10159 portonovo

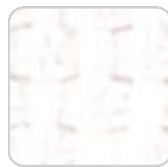

# VONDOM

ecru 10151 portonovo



clay 10156 portonovo

brown 10158 portonovo



anthracite 10164 portonovo

white 10150 portonovo



mustard 10155 portonovo

black 10165 portonovo



gray 10163 portonovo

garnet 10157 portonovo



camel 10154 portonovo



blue 10162 portonovo

Group 1A. Tejido 100% acrilico, con diseño liso y sencillo, que se adapta a cualquier estilo.

## ALTEA

Ref. 54095CO



tortora 1102 altea



white 1100 altea



camel 1120 altea



clay 1122 altea



garnet 1106 altea



brown 1104 altea



jade 1125 altea



ocean 1123 altea



gray 1101 altea



anthracite 1124 altea



black 1105 altea

Group 1A. Tejido suave para exteriores, con textura similar a la piel.

## AROUSA

# VONDOM

Ref. 54095CO



tortora 1209 arousa



camel 1230 arousa



clay 1231 arousa



brown 1214 arousa

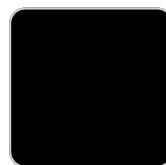

jade 1235 arousa



gray 1208 arousa



anthracite 1210  
arousa

Group 1B. Tejido suave para exteriores, con acabado brillante.

## Ambients

---

