

Tablet butaca 110x107x81

por Ramón Esteve

El sofá de exterior de la colección Tablet, diseñado por Ramon Esteve para Vondom, busca **relacionar las nuevas tecnologías y su flexibilidad** a la versatilidad de la composición modular creando un programa de sofás basado en la dualidad identidad e integración. La personalidad de la pieza convive con el espacio y a su vez se adapta al estilo del mismo.



Info

Descripción

Mobiliario fabricado en poliuretano flexible inyectado en frío. Este material posee una alta resiliencia y durabilidad.

La espuma flexible de poliuretano posee una estructura celular abierta, es un material muy elástico. Dificulta el crecimiento de hongos y bacterias.

Peso: 42.76 Kg

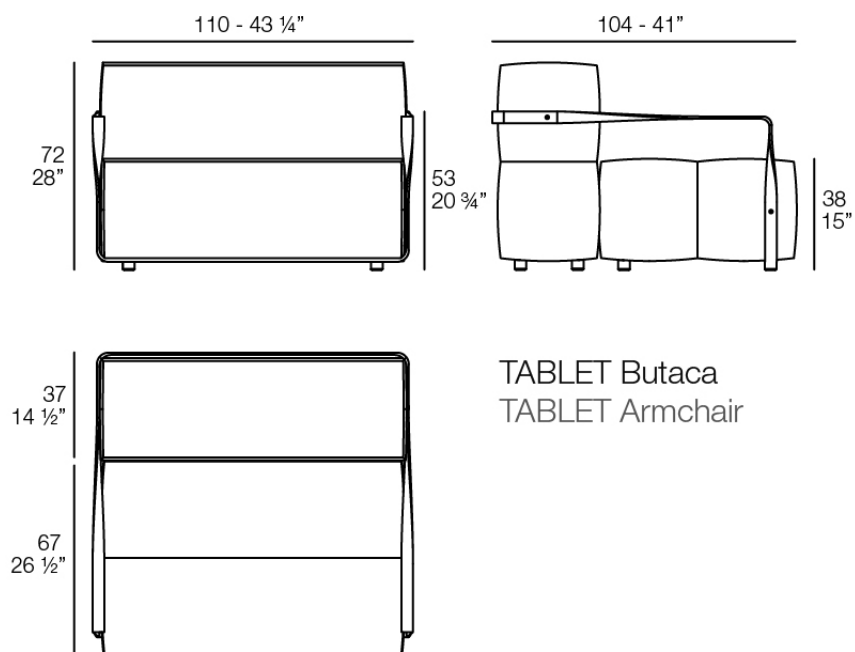

Acabados

acabados

Polyurethane

Ref. 54319

Mobiliario fabricado en poliuretano flexible inyectado en frio. Este material posee una alta resistencia y durabilidad.

estructura

Aluminium

Ref. VVAR03085



white



anthracite



black

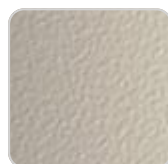

cream



ecru



tortora



garnet



brown



smoked



green



blue

Ref. VVAR03085



gray

tejidos

GETARIA

Ref. 54214T



aquamarine 10003
getaria



cream 10047 getaria



gray 10042 getaria



iceberg 10037 getaria



ocean 10023 getaria



dune 10009 getaria



oversea 10002 getaria



green 10053 getaria



garnet 10046 getaria



white 10041 getaria



camel 10033 getaria



emerald 10016
getaria



granite 10008 getaria



brown 10050 getaria



black 10044 getaria



moon 10040 getaria



gallant 10025 getaria



niord 10015 getaria



oasis 10007 getaria



tortora 10048 getaria

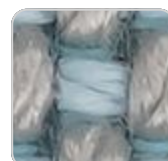
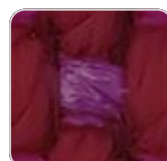
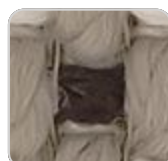

VONDOM

anthracite 10043
getaria

terra 10039 getaria

blue 10024 getaria

aphrodite 10013
getaria

pearl 10006 getaria

Group 2. Tejido premium 1005 acrilico, con una alta densidad, presente en una amplia gama de colores.

ZUMAIA Ref. 54214T



green 10204 zumaia



white 10200 zumaia



blue 10203 zumaia



garnet 10202 zumaia



black 10205 zumaia



cream 10201 zumaia

Group 2. Tejido elegante 100% acrilico, con un rizo suave, agradable al tacto y una combinacion de colores distintiva.

SUANCES Ref. 54214T



anthracite 10314
suances



green 10310 suances



clay 10306 suances

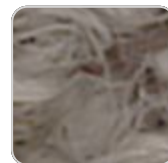

tortora 10302 suances



olive 10317 suances



gray 10313 suances



jade 10309 suances



mustard 10305
suances

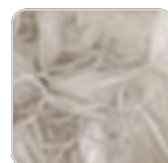

ecru 10301 suances



peach 10316 suances

VONDOM



blue 10312 suances



brown 10308 suances



camel 10304 suances

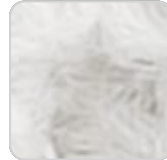

white 10300 suances



black 10315 suances



ocean 10311 suances



garnet 10307 suances



cream 10303 suances

Group 2. Tejido de rizo, destaca por su calidez y suavidad, con colores combinados que añaden profundidad y elegancia.

RIBADEO Ref. 54214T



brown 10328 ribadeo



camel 10324 ribadeo

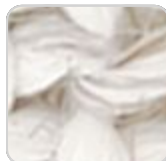

white 10320 ribadeo



olive 10336 ribadeo



blue 10332 ribadeo



garnet 10327 ribadeo



cream 10323 ribadeo



peach 10335 ribadeo

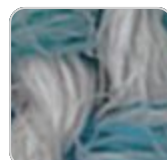

ocean 10331 ribadeo

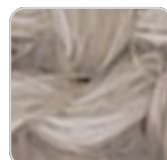

tortora 10322 ribadeo



anthracite 10334
ribadeo



green 10330 ribadeo



clay 10326 ribadeo



ecru 10321 ribadeo



mint 10337 ribadeo

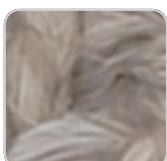

gray 10333 ribadeo



jade 10329 ribadeo



mustard 10325
ribadeo

VONDOM

Group 2. Suave tejido que presenta hilos jaspeados de diferentes grosores que crean una textura rica y visualmente interesante. Su apariencia de lino añade un toque de estilo natural.

LOURO

Ref. 54214T



olive 10356 louro



green 10350 louro



brown 10348 louro



tortora 10342 louro



peach 10355 louro



jade 10349 louro



garnet 10347 louro

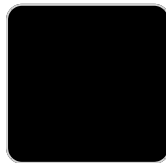

ecru



anthracite 10354 louro



clay 10346 louro

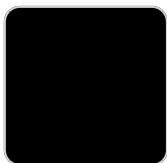

white



gray 10353 louro



mustard 10345 louro

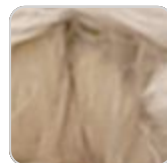

camel 10344 louro

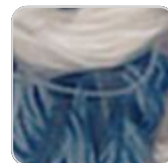

blue 10352 louro



cream 10343 louro



ocean 10351 louro

Group 2. Tejido suave y versátil que presenta un color neutro de base que facilita su integración con diversos colores y tejidos.

Ambients

