

Posidonia izquierdo

por Ramón Esteve

Posidonia, la **nueva colección de muebles de exterior de diseño** es capaz de crear una atmósfera de serenidad y equilibrio, despertando la sensibilidad del usuario e invitándole a disfrutar cada momento.



Info

Descripción

Peso: 23.98 Kg

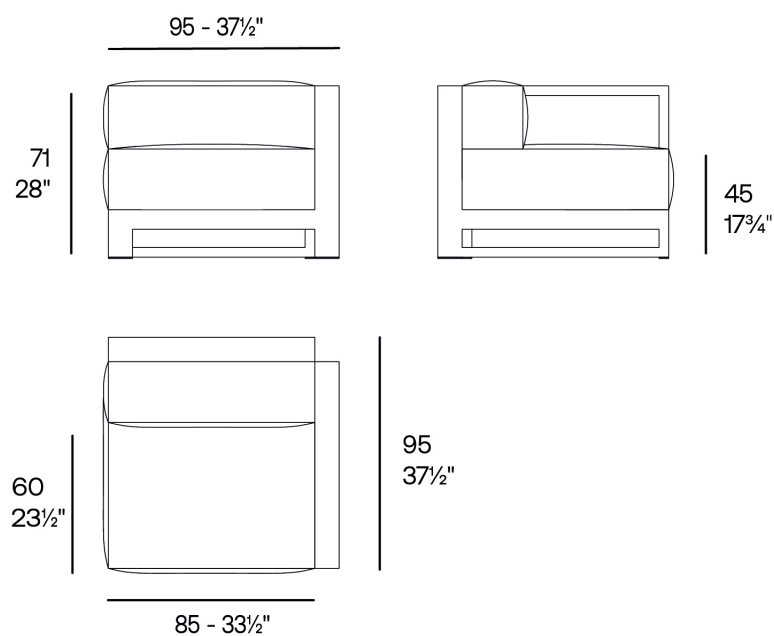

POSIDONIA Módulo izquierdo
POSIDONIA Left armrest section

Acabados

acabados

ALUMINIO

Ref. 54752



white



smoked



ecru



tortora



cream



camel



clay



garnet



brown



green



blue



gray



anthracite



black



ocean

Perfil de aluminio en acabado lacado.

tejidos

GETARIA

Ref. 54754CO

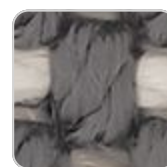
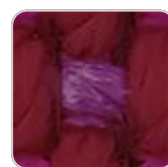

VONDOM

white 10041 getaria



niord 10015 getaria



green 10053 getaria



aphrodite 10013
getaria



moon 10040 getaria



dune 10009 getaria



terra 10039 getaria



brown 10050 getaria



camel 10033 getaria



tortora 10048 getaria



granite 10008 getaria



gallant 10025 getaria



cream 10047 getaria



oasis 10007 getaria

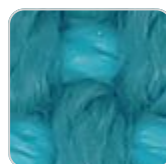

garnet 10046 getaria



pearl 10006 getaria



blue 10024 getaria

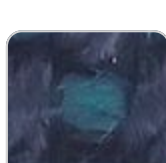

black 10044 getaria



aquamarine 10003
getaria



ocean 10023 getaria



anthracite 10043
getaria

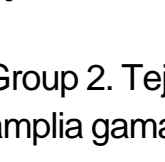

oversea 10002 getaria

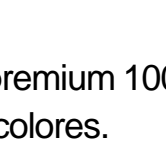

emerald 10016
getaria

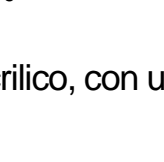

Group 2. Tejido premium 1005 acrilico, con una alta densidad, presente en una amplia gama de colores.

BAIONA Ref. 54754CO

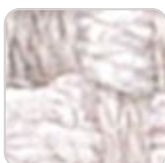

white 10100 baiona



blue 10112 baiona

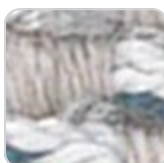

ocean 10111 baiona

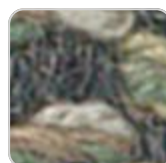

green 10110 baiona



clay 10106 baiona



jade 10109 baiona



camel 10104 baiona



brown 10108 baiona

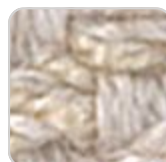

cream 10103 baiona



garnet 10107 baiona

VONDOM



black 10114 baiona



tortora 10102 baiona



gray 10113 baiona

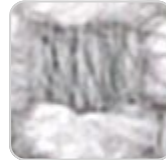

ecru 10101 baiona

Group 1C. Tejido 100% acrilico de alta densidad, que aporta sensacion de solidez y un patron irregular que añade un toque artesanal.

CALELLA

Ref. 54754CO



clay 10125 calella



mustard 10124 calella



cream 10123 calella



tortora 10122 calella

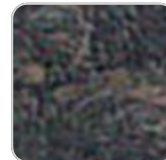

anthracite 10129
calella



ecru 10121 calella

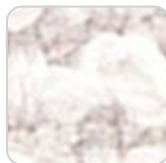

white 10120 calella



gray 10128 calella



blue 10127 calella



jade 10126 calella

Group 1C. Tejido 100% acrilico libre de PFAS, con una textura rica e inusual y una suavidad excepcional, que mejora la comodidad de los muebles.

FISTERRA

Ref. 54754CO



cream 10132 fisterra



white 10130 fisterra



ecru 10131 fisterra

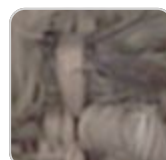

tortora 10135 fisterra



camel 10134 fisterra

VONDOM



peach 10146 fisterra



clay 10137 fisterra



garnet 10138 fisterra

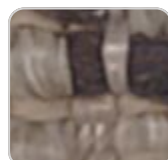

brown 10136 fisterra

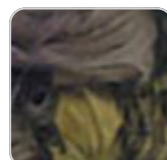

olive 10145 fisterra



jade 10139 fisterra



green 10140 fisterra



ocean 10141 fisterra



blue 10142 fisterra



gray 10143 fisterra



anthracite 10144
fisterra



black 10147 fisterra

Group 1C. Tejido 100% acrilico, con un patron irregular jaspeado muy distintivo y un tacto suave.

PORTONOVO Ref. 54754CO



gray 10163 portonovo



tortora 10152
portonovo

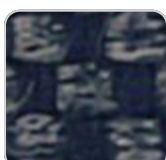

blue 10162 portonovo



ecru 10151 portonovo



ocean 10161
portonovo

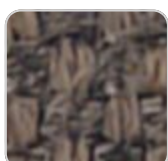

brown 10158
portonovo

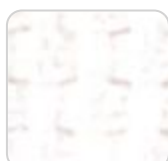

white 10150
portonovo

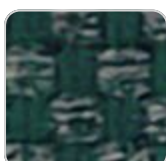

green 10160
portonovo

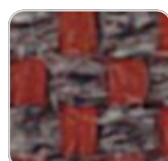

garnet 10157
portonovo

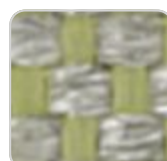

jade 10159 portonovo

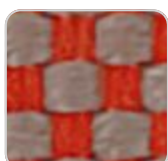

clay 10156 portonovo

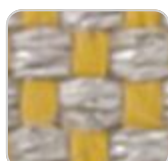

mustard 10155
portonovo



black 10165
portonovo

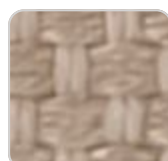

camel 10154
portonovo

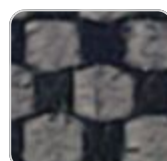

anthracite 10164
portonovo

VONDOM



cream 10153
portonovo

Group 1A. Tejido 100% acrilico, con diseño liso y sencillo, que se adapta a cualquier estilo.

ZUMAIA Ref. 54754CO



black 10205 zumaia



green 10204 zumaia



blue 10203 zumaia



garnet 10202 zumaia



cream 10201 zumaia



white 10200 zumaia

Group 2. Tejido elegante 100% acrilico, con un rizo suave, agradable al tacto y una combinacion de colores distintiva.

SUANCES Ref. 54754CO



garnet 10307 suances



ocean 10311 suances



clay 10306 suances



green 10310 suances



mustard 10305
suances

VONDOM



jade 10309 suances



olive 10317 suances



camel 10304 suances



peach 10316 suances

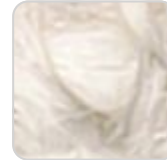

cream 10303 suances



black 10315 suances



tortora 10302 suances



anthracite 10314 suances

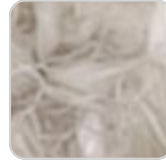

ecru 10301 suances

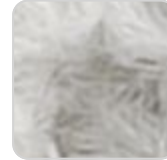

gray 10313 suances



white 10300 suances



brown 10308 suances



blue 10312 suances

Group 2. Tejido de rizo, destaca por su calidez y suavidad, con colores combinados que añaden profundidad y elegancia.

RIBADEO

Ref. 54754CO



ecru 10321 ribadeo



olive 10336 ribadeo



jade 10329 ribadeo



peach 10335 ribadeo



brown 10328 ribadeo

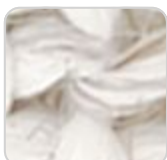

white 10320 ribadeo

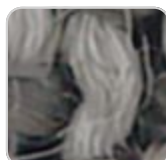

anthracite 10334 ribadeo



garnet 10327 ribadeo



gray 10333 ribadeo



clay 10326 ribadeo



mustard 10325 ribadeo

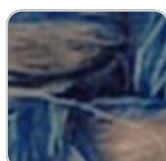

blue 10332 ribadeo



camel 10324 ribadeo

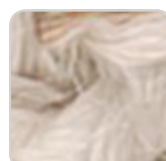

cream 10323 ribadeo



ocean 10331 ribadeo

VONDOM



tortora 10322 ribadeo



mint 10337 ribadeo



green 10330 ribadeo

Group 2. Suave tejido que presenta hilos jaspeados de diferentes grosores que crean una textura rica y visualmente interesante. Su apariencia de lino añade un toque de estilo natural.

LOURO

Ref. 54754CO



olive 10356 louro



brown 10348 louro



peach 10355 louro



garnet 10347 louro



clay 10346 louro



anthracite 10354 louro



mustard 10345 louro



gray 10353 louro



camel 10344 louro

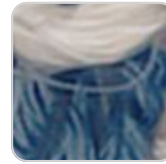

blue 10352 louro



ocean 10351 louro



cream 10343 louro



green 10350 louro



tortora 10342 louro

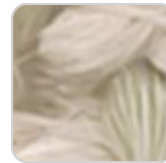

jade 10349 louro

Group 2. Tejido suave y versatil que presenta un color neutro de base que facilita su integracion con diversos colores y tejidos.

ALTEA

Ref. 54754CO

VONDOM



tortora 1102 altea

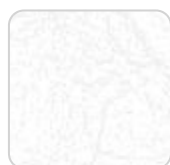

white 1100 altea



camel 1120 altea



clay 1122 altea



garnet 1106 altea



brown 1104 altea



jade 1125 altea



ocean 1123 altea



gray 1101 altea



anthracite 1124 altea



black 1105 altea

Group 1A. Tejido suave para exteriores, con textura similar a la piel.

AROUSA

Ref. 54754CO



tortora 1209 arousa



camel 1230 arousa



clay 1231 arousa

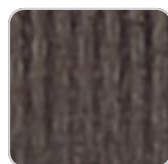

brown 1214 arousa

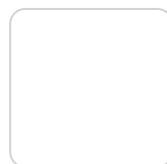

jade 1235 arousa



gray 1208 arousa

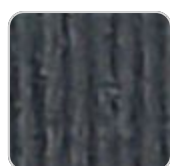

anthracite 1210
arousa

Group 1B. Tejido suave para exteriores, con acabado brillante.

Ambients

