

Hamptons butaca

por Ramón Esteve

Hamptons, la **nueva colección de muebles de exterior de diseño** se compone de un conjunto de piezas donde una cuidada selección de tejidos y patrones evocan ese "lifestyle" donde la elegancia se percibe en los más finos detalles.



Info

Descripción

Ramón Esteve ha diseñado una butaca elegante con una sólida estructura de aluminio, detalles de teca y patas de aluminio pulido. Su tapicería, pensada para uso en exteriores, combina resistencia climática con la comodidad de un tejido de interior.

Disponible en una variada paleta de colores, es versátil para adaptarse a espacios tanto al aire libre como en interiores.

Peso: 21.63 Kg

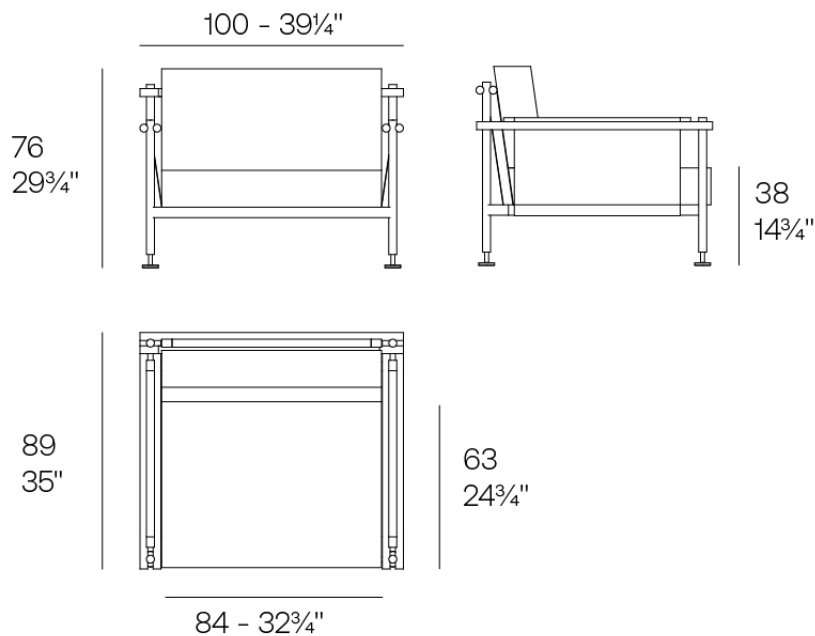

HAMPTONS Butaca
HAMPTONS Lounge Chair

Acabados

acabados

Aluminium
Ref. 54800



white



smoked



ecru



tortora

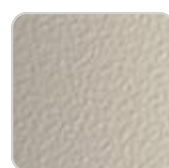

cream



garnet



brown



green



blue



gray



anthracite



black

Perfil de aluminio en acabado lacado.

tejidos

BAIONA
Ref. 54800CO

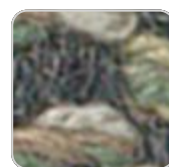
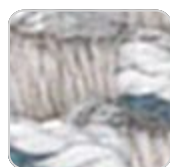
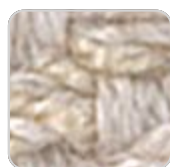

VONDOM

blue 10112 baiona



cream 10103 baiona

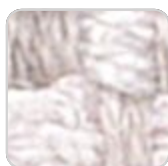

ocean 10111 baiona



tortora 10102 baiona



green 10110 baiona



ecru 10101 baiona

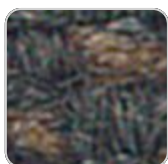

white 10100 baiona



jade 10109 baiona



brown 10108 baiona



garnet 10107 baiona



black 10114 baiona

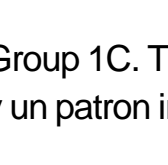

clay 10106 baiona

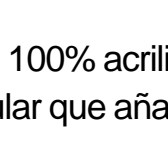

gray 10113 baiona

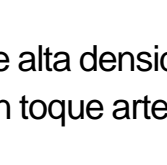

camel 10104 baiona

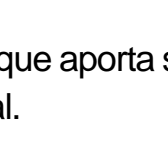

Group 1C. Tejido 100% acrilico de alta densidad, que aporta sensacion de solidez y un patron irregular que añade un toque artesanal.

CALELLA

Ref. 54800CO



clay 10125 calella



mustard 10124 calella



cream 10123 calella

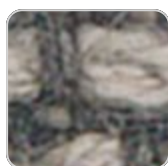

tortora 10122 calella

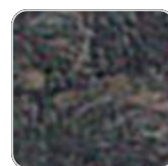

anthracite 10129 calella



ecru 10121 calella



gray 10128 calella



white 10120 calella



blue 10127 calella



jade 10126 calella

Group 1C. Tejido 100% acrilico libre de PFAS, con una textura rica e inusual y una suavidad excepcional, que mejora la comodidad de los muebles.

FISTERRA

Ref. 54800CO

VONDOM



cream 10132 fisterra



white 10130 fisterra



ecru 10131 fisterra



tortora 10135 fisterra



camel 10134 fisterra



peach 10146 fisterra



clay 10137 fisterra



garnet 10138 fisterra



brown 10136 fisterra



olive 10145 fisterra



jade 10139 fisterra



green 10140 fisterra



ocean 10141 fisterra



blue 10142 fisterra



gray 10143 fisterra



anthracite 10144
fisterra



black 10147 fisterra

Group 1C. Tejido 100% acrilico, con un patron irregular jaspeado muy distintivo y un tacto suave.

AROUSA Ref. 54800CO



tortora 1209 arousa



camel 1230 arousa



clay 1231 arousa



brown 1214 arousa

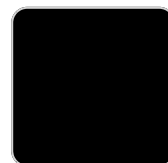

jade 1235 arousa



gray 1208 arousa



anthracite 1210
arousa

Group 1B. Tejido suave para exteriores, con acabado brillante.

LLANES

Ref. 54800TEL



anthracite 10183
llanes



gray 10182 llanes



tortora 10181 llanes

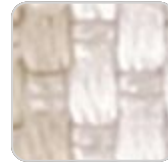

crema 10180 llanes

Group 3A. Tejido que presenta un diseño clasico de rayas y una composicion 100% acrilica, combinando elegancia y funcionalidad.

ROSES

Ref. 54800TEL

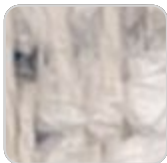

blue 10405 roses



tortora 10404 roses

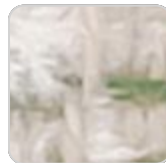

green 10403 roses

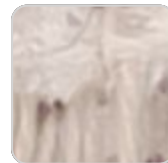

garnet 10402 roses

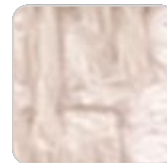

cream 10400 roses

Group 3A. Tejido de rizo pequeño con tratamiento anti-manchas y propiedades hidropelentes, que combina funcionalidad y estilo

Ambients

