

Luna planter ø85x58cm

por Ramón Esteve

Luna canaliza el espíritu revolucionario de iconos como Verner Panton y Joe Colombo. Con su uso de materiales vanguardistas y formas atrevidas, Luna es una oda a la democratización del diseño, que combina funcionalidad, estética impactante y una elegancia atemporal que redefine la sofisticación en el mobiliario contemporáneo.



Info

Descripción

Peso: 13 Kg

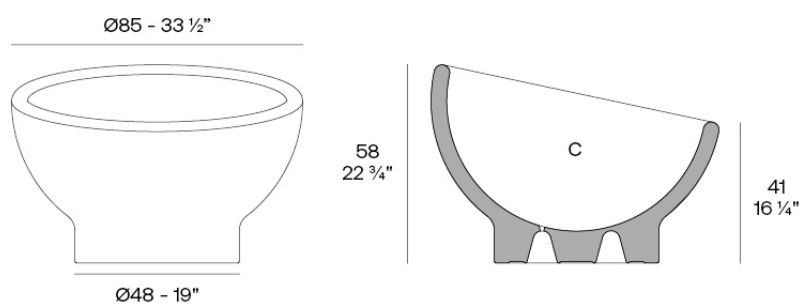

Luna. Macetero Ø85 cm
Luna. Planter 15 1/2"
54857

C = 78 L
C = 20 1/2 gal

Acabados

acabados

Basic

Ref. 54857



white 2001



black 2002



ecru 2003



tortora 2004



gray 2005



anthracite 2006



brown 2008



garnet 2015



green 2016



cream 2017



blue 2018



camel 2020



clay 2022



ecru granite



cream granite



ice 2101

Resina de polietileno acabado mate.

Lacquered

Ref. 54857F

VONDOM



white 3101



black 3102



ecru 3103



tortora 3104



gray 3105



anthracite 3106



garnet 3113



green 3116



cream 3117



blue 3118



camel 3120



clay



brown 3125

Resina de polietileno con un acabado lacado brillo.

