

Luna lampara 61x61x55

por Ramón Esteve

Luna canaliza el espíritu revolucionario de iconos como Verner Panton y Joe Colombo. Con su uso de materiales vanguardistas y formas atrevidas, Luna es una oda a la democratización del diseño, que combina funcionalidad, estética impactante y una elegancia atemporal que redefine la sofisticación en el mobiliario contemporáneo.



Info

Descripción

Peso: 6.9 Kg

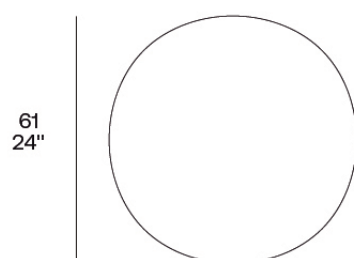
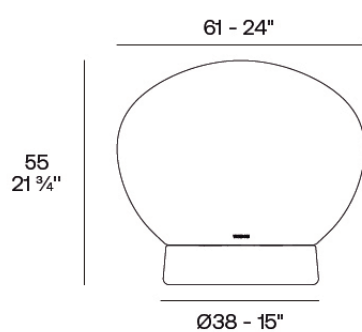

Luna. Lámpara 61x61x55 cm
Luna. Lamp 24" x 24" x 21 3/4"
54863

Acabados

acabados

Basic

Ref. 54863

Resina de polietileno acabado mate.

luz

Led – White

Ref. 54863W

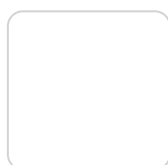

white 2001

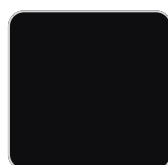

black 2002



ecru 2003



tortora 2004



gray 2005



anthracite 2006



brown 2008

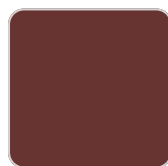

garnet 2015



green 2016



cream 2017



blue 2018

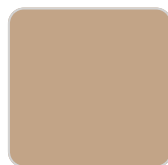

camel 2020

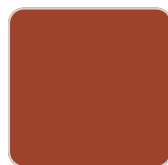

clay 2022



ecru granite



cream granite

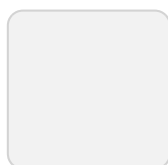

ice 2101

Con iluminación interior de color blanco mediante tecnología LED. Solo disponible en acabado hielo mate.

LED RGBW – Cable

Ref. 54863L



white 2001



black 2002

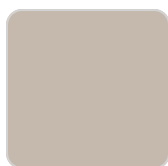

ecru 2003

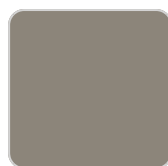

tortora 2004



gray 2005



anthracite 2006



brown 2008



garnet 2015



green 2016

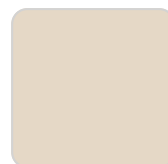

cream 2017



blue 2018

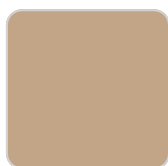

camel 2020

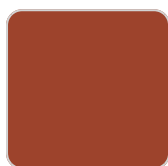

clay 2022

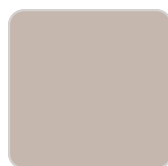

ecru granite



cream granite

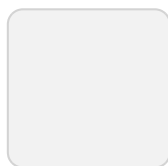

ice 2101

Con iluminación interior mediante tecnología LED RGBW y mando a distancia para cambiar de color. Solo disponible en acabado hielo mate. Acompañado de un mando a distancia para el cambio de color* por selección o de forma automática.

LED RGBW DMX – Cable

Ref. 54863D

VONDOM



white 2001

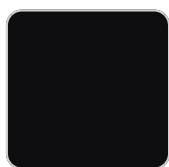

black 2002

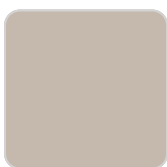

ecru 2003



tortora 2004



gray 2005

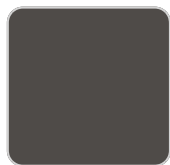

anthracite 2006

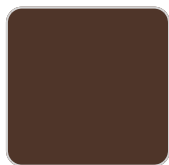

brown 2008

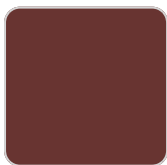

garnet 2015



green 2016



cream 2017



blue 2018

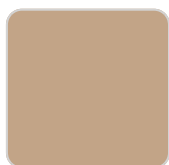

camel 2020

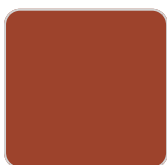

clay 2022



ecru granite



cream granite

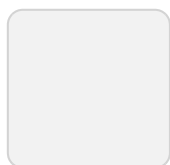

ice 2101

Con iluminación interior mediante tecnología LED RGBW y mando a distancia para cambiar de color. Controlado también por DMX-1024 (wireless). Solo disponible en acabado hielo mate, permitiendo la comunicación entre uno o múltiples productos simultáneamente mediante el transmisor DMX (no incluido). Hay dos opciones para seleccionar. Professional XLR DMX y Home WIFI DMX.

LED RGBW – Battery

Ref. 54863Y



white 2001



black 2002

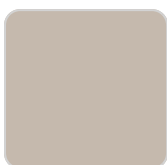

ecru 2003

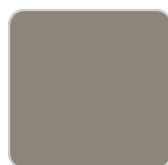

tortora 2004



gray 2005

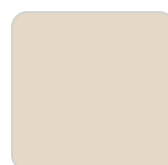
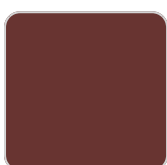

VONDOM

anthracite 2006



blue 2018

brown 2008

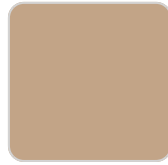

camel 2020

garnet 2015

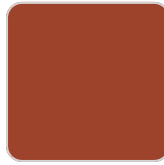

clay 2022

green 2016

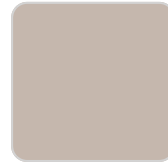

ecru granite

cream 2017



cream granite



ice 2101

Con iluminación interior mediante tecnología LED RGBW, alimentado por una batería. Se incluye mando a distancia para cambiar de color y cargador. Solo disponible en acabado hielo mate.

LED RGBW DMX – Battery Ref. 54863DY



white 2001



black 2002

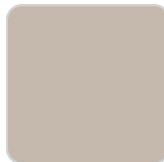

ecru 2003



tortora 2004



gray 2005



anthracite 2006



brown 2008

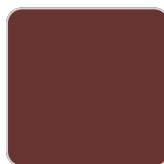

garnet 2015



green 2016



cream 2017



blue 2018

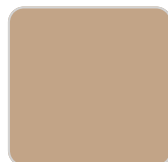

camel 2020

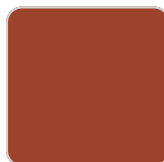

clay 2022



ecru granite



cream granite

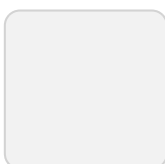

ice 2101

VONDOM

Con iluminación interior mediante tecnología LED RGBW, alimentado por una batería. Incluye mando a distancia para cambiar de color. Controlado también por DMX-1024 (wireless). Solo disponible en acabado hielo mate. permitiendo la comunicación entre uno o multiples productos simultaneamente mediante el transmisor DMX (no incluido). Hay dos opciones para seleccionar. Professional XLR DMX y Home WIFI DMX.

