

## Spritz tumbona

por Archirivolto Design

Spritz, diseñada por Archirivolto Design, captura la esencia de las tardes de verano con una línea de muebles exteriores que combina simplicidad y funcionalidad. Inspirada en las vallas blancas de playa y sus delicadas geometrías, cada pieza aporta un toque de frescura y elegancia a un espacio exterior.



## Info

---

### Descripción

Fabricado en polipropileno por inyección y reforzado con fibra de vidrio. Apilable. Disponible en varios colores. Apto para uso interior y exterior.

Peso: 18.49 Kg

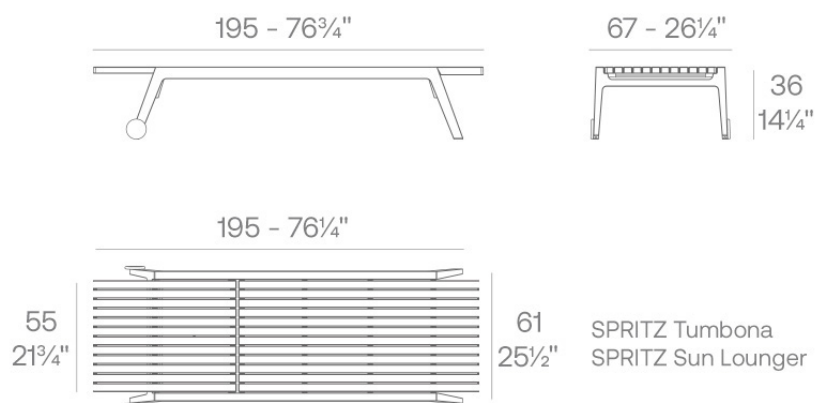

## Acabados

---

### acabados

---

Basic

Ref. 56027



white

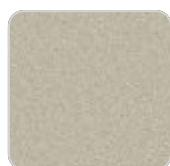

ecu

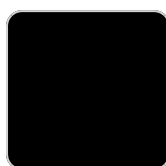

tortora

Disponibile en varios colores

### tejidos

---

BAIONA

Ref. 56027CO



green 10110 baiona

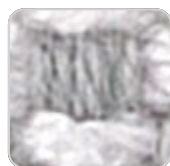

ecu 10101 baiona

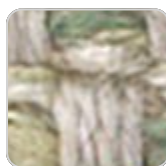

jade 10109 baiona

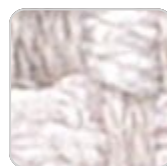

white 10100 baiona



brown 10108 baiona



garnet 10107 baiona

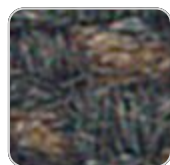

black 10114 baiona



clay 10106 baiona



gray 10113 baiona

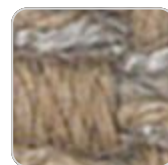

camel 10104 baiona

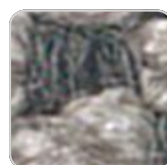
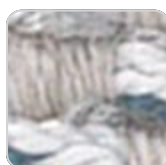
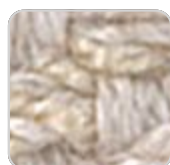

blue 10112 baiona

cream 10103 baiona

ocean 10111 baiona

tortora 10102 baiona

Group 1C. Tejido 100% acrilico de alta densidad, que aporta sensacion de solidez y un patron irregular que añade un toque artesanal.

## CALELLA

Ref. 56027CO



cream 10123 calella



tortora 10122 calella



anthracite 10129  
calella



ecru 10121 calella

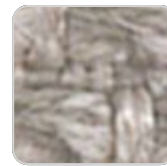

gray 10128 calella



white 10120 calella



blue 10127 calella



jade 10126 calella



clay 10125 calella



mustard 10124 calella

Group 1C. Tejido 100% acrilico libre de PFAS, con una textura rica e inusual y una suavidad excepcional, que mejora la comodidad de los muebles.

## FISTERRA

Ref. 56027CO



cream 10132 fisterra



white 10130 fisterra



ecru 10131 fisterra



tortora 10135 fisterra



camel 10134 fisterra



peach 10146 fisterra



clay 10137 fisterra



garnet 10138 fisterra



brown 10136 fisterra



olive 10145 fisterra

# VONDOM



jade 10139 fisterra



green 10140 fisterra



ocean 10141 fisterra



blue 10142 fisterra



gray 10143 fisterra



anthracite 10144  
fisterra



black 10147 fisterra

Group 1C. Tejido 100% acrilico, con un patron irregular jaspeado muy distintivo y un tacto suave.

## PORTONOVO Ref. 56027CO

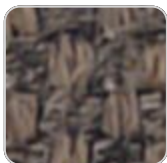

brown 10158  
portonovo

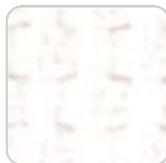

white 10150  
portonovo



black 10165  
portonovo



garnet 10157  
portonovo



anthracite 10164  
portonovo



clay 10156 portonovo



gray 10163 portonovo



mustard 10155  
portonovo

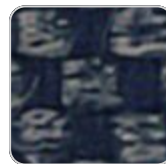

blue 10162 portonovo



camel 10154  
portonovo



cream 10153  
portonovo



ocean 10161  
portonovo



tortora 10152  
portonovo

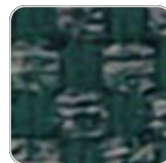

green 10160  
portonovo

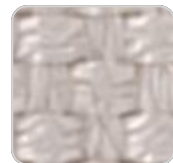

ecru 10151 portonovo



jade 10159 portonovo

# VONDOM

Group 1A. Tejido 100% acrilico, con diseño liso y sencillo, que se adapta a cualquier estilo.

## ALTEA

Ref. 56027CO



tortora 1102 altea



white 1100 altea



camel 1120 altea



clay 1122 altea



garnet 1106 altea



brown 1104 altea



jade 1125 altea



ocean 1123 altea



gray 1101 altea



anthracite 1124 altea



black 1105 altea

Group 1A. Tejido suave para exteriores, con textura similar a la piel.

## AROUSA

Ref. 56027CO



tortora 1209 arousa



camel 1230 arousa



clay 1231 arousa



brown 1214 arousa

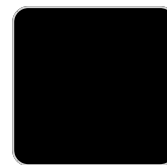

jade 1235 arousa



gray 1208 arousa



anthracite 1210  
arousa

# VONDOM

Group 1B. Tejido suave para exteriores, con acabado brillante.

## Ambients

---

