

Ibiza silla con brazos

por Eugeni Quitllet

La colección Ibiza de Vondom, diseñada por Eugeni Quitllet, captura la esencia de la vida junto al mar y la belleza efímera de una temporada transformada en piezas eternas. Inspirada en la brisa marina y el sol del Mediterráneo, Ibiza es una oda al diseño sostenible y al estado de ánimo emocional que define esta icónica isla.



Info

Descripción

Fabricado en polipropileno por inyección con gas y reforzado con fibra de vidrio. Apilable. Disponible en varios colores. Apto para uso interior y exterior.

Peso: 5.56 Kg

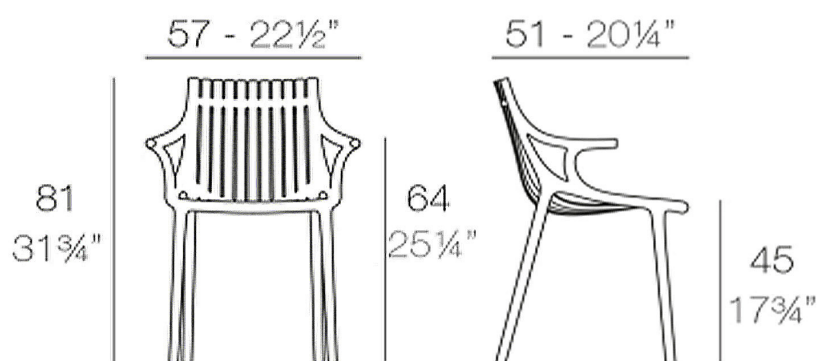

IBIZA Silla con brazos
IBIZA Chair with arms

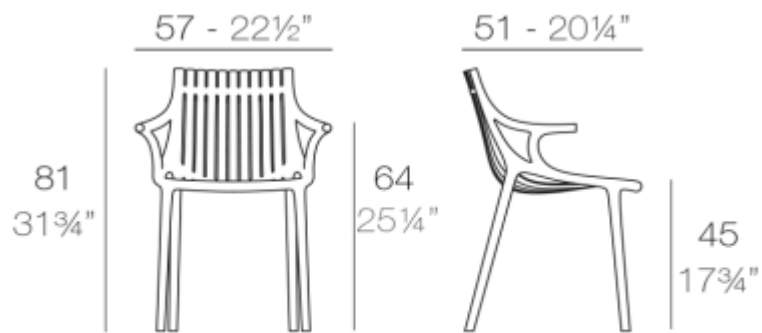

IBIZA Silla con brazos
IBIZA Chair with arms

Acabados

acabados

Basic

Ref. 65044

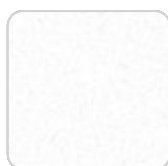

white



black



ecru



jade

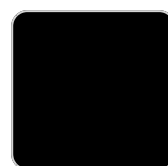

tortora

Disponibile en varios colores

tejidos

BAIONA

Ref. 65044CO



blue 10112 baiona

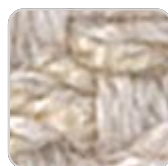

cream 10103 baiona

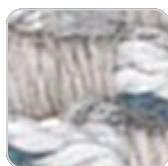

ocean 10111 baiona



tortora 10102 baiona



ecru 10101 baiona



green 10110 baiona

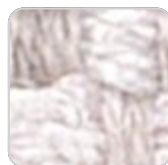

white 10100 baiona



jade 10109 baiona



brown 10108 baiona



garnet 10107 baiona

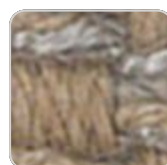

VONDOM

black 10114 baiona

clay 10106 baiona

gray 10113 baiona

camel 10104 baiona

Group 1C. Tejido 100% acrilico de alta densidad, que aporta sensacion de solidez y un patron irregular que añade un toque artesanal.

CALELLA

Ref. 65044CO



clay 10125 calella



mustard 10124 calella



cream 10123 calella



tortora 10122 calella



anthracite 10129
calella



ecru 10121 calella



gray 10128 calella



white 10120 calella



blue 10127 calella



jade 10126 calella

Group 1C. Tejido 100% acrilico libre de PFAS, con una textura rica e inusual y una suavidad excepcional, que mejora la comodidad de los muebles.

FISTERRA

Ref. 65044CO



cream 10132 fisterra



white 10130 fisterra



ecru 10131 fisterra

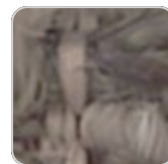

tortora 10135 fisterra



camel 10134 fisterra



peach 10146 fisterra



clay 10137 fisterra



garnet 10138 fisterra

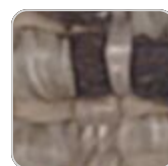

brown 10136 fisterra

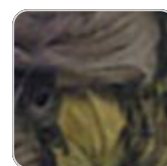

olive 10145 fisterra

VONDOM



jade 10139 fisterra



green 10140 fisterra



ocean 10141 fisterra



blue 10142 fisterra



gray 10143 fisterra



anthracite 10144
fisterra



black 10147 fisterra

Group 1C. Tejido 100% acrilico, con un patron irregular jaspeado muy distintivo y un tacto suave.

PORTONOVO Ref. 65044CO



green 10160
portonovo



tortora 10152
portonovo



jade 10159 portonovo

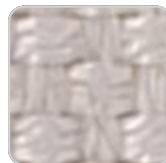

ecru 10151 portonovo

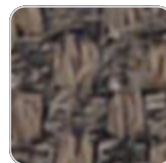

brown 10158
portonovo



white 10150
portonovo



black 10165
portonovo



garnet 10157
portonovo



anthracite 10164
portonovo



clay 10156 portonovo



mustard 10155
portonovo



gray 10163 portonovo



camel 10154
portonovo

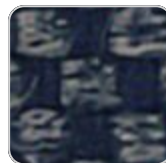

blue 10162 portonovo



cream 10153
portonovo



ocean 10161
portonovo

VONDOM

Group 1A. Tejido 100% acrilico, con diseño liso y sencillo, que se adapta a cualquier estilo.

ALTEA

Ref. 65044CO



tortora 1102 altea



white 1100 altea



camel 1120 altea



clay 1122 altea



garnet 1106 altea



brown 1104 altea



jade 1125 altea



ocean 1123 altea



gray 1101 altea



anthracite 1124 altea



black 1105 altea

Group 1A. Tejido suave para exteriores, con textura similar a la piel.

AROUSA

Ref. 65044CO



tortora 1209 arousa



camel 1230 arousa



clay 1231 arousa



brown 1214 arousa

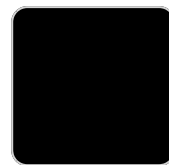

jade 1235 arousa



gray 1208 arousa



anthracite 1210
arousa

VONDOM

Group 1B. Tejido suave para exteriores, con acabado brillante.

Ambients

