

## Milos tumbona

por Jean-Marie Massaud

La colección Milos es el fruto de la colaboración entre Vondom y el reconocido diseñador francés Jean-Marie Massaud, combinando simplicidad y funcionalidad en piezas que destacan por su diseño audaz y su confort. Con curvas suaves y formas inspiradas en la naturaleza, la colección de muebles de exterior ofrece una experiencia única, razón por la cual ha sido galardonada con el prestigioso premio de diseño Red Dot 2024.



## Info

---

### Descripción

La tumbona de la colección Milos combina armoniosamente funcionalidad y belleza. Creada con precisión, esta tumbona presenta una estructura de aluminio lacado que garantiza una resistencia excepcional a las condiciones exteriores.

Sus patas de madera de iroko añaden un toque de elegancia y calidez, al tiempo que proporcionan estabilidad y una conexión con la naturaleza.

Peso: 33 Kg

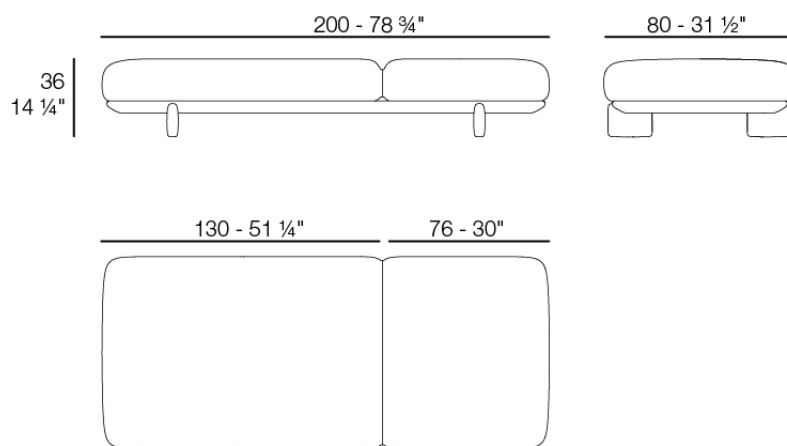

MILOS Tumbona  
MILOS Sun Chaise  
Ref. 70013

## Acabados

---

### acabados

---

Polyurethane

Ref. 70013

Mobiliario fabricado en poliuretano flexible inyectado en frio. Este material posee una alta resistencia y durabilidad.

### acabados

---

Ref. 70013AF

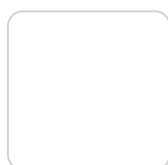

white



smoked



ecru



tortora



cream

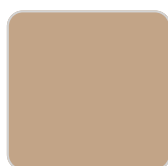

camel

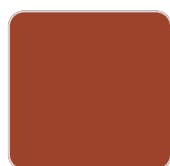

clay

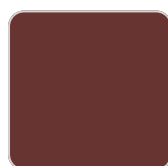

garnet



brown



green



blue



gray



anthracite



black



ocean

## tejidos

---

### GETARIA

Ref. 70013CO



anthracite 10043  
getaria



emerald 10016  
getaria



white 10041 getaria



niord 10015 getaria



dune 10009 getaria



moon 10040 getaria

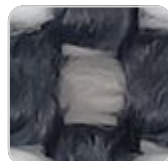

granite 10008 getaria



brown 10050 getaria



terra 10039 getaria



oasis 10007 getaria



tortora 10048 getaria



camel 10033 getaria

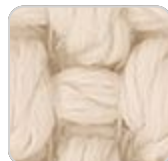

cream 10047 getaria



gallant 10025 getaria

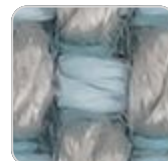

pearl 10006 getaria



garnet 10046 getaria



blue 10024 getaria



oversea 10002 getaria



black 10044 getaria



ocean 10023 getaria

Group 2. Tejido premium 1005 acrilico, con una alta densidad, presente en una amplia gama de colores.

### ZUMAIA

Ref. 70013CO



garnet 10202 zumaia



cream 10201 zumaia

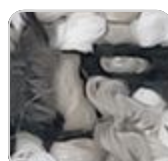

white 10200 zumaia



black 10205 zumaia

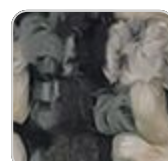

green 10204 zumaia

# VONDOM



blue 10203 zumaia

Group 2. Tejido elegante 100% acrilico, con un rizo suave, agradable al tacto y una combinacion de colores distintiva.

## SUANCES

Ref. 70013CO



blue 10312 suances



camel 10304 suances



ocean 10311 suances

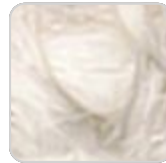

cream 10303 suances



green 10310 suances



tortora 10302 suances



jade 10309 suances



ecru 10301 suances



olive 10317 suances

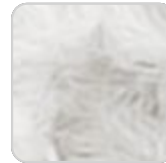

white 10300 suances



peach 10316 suances



brown 10308 suances



black 10315 suances

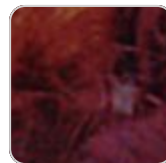

garnet 10307 suances

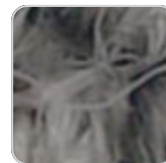

anthracite 10314  
suances



clay 10306 suances



gray 10313 suances



mustard 10305  
suances

Group 2. Tejido de rizo, destaca por su calidez y suavidad, con colores combinados que añaden profundidad y elegancia.

## RIBADEO

# VONDOM

Ref. 70013CO



tortora 10322 ribadeo



green 10330 ribadeo



mint 10337 ribadeo



jade 10329 ribadeo



ecru 10321 ribadeo



olive 10336 ribadeo



brown 10328 ribadeo



white 10320 ribadeo



peach 10335 ribadeo



garnet 10327 ribadeo



anthracite 10334  
ribadeo



clay 10326 ribadeo



mustard 10325  
ribadeo



gray 10333 ribadeo



camel 10324 ribadeo



blue 10332 ribadeo



cream 10323 ribadeo



ocean 10331 ribadeo

Group 2. Suave tejido que presenta hilos jaspeados de diferentes grosores que crean una textura rica y visualmente interesante. Su apariencia de lino añade un toque de estilo natural.

## LOURO

Ref. 70013CO



green 10350 louro



tortora 10342 louro



jade 10349 louro



olive 10356 louro



brown 10348 louro

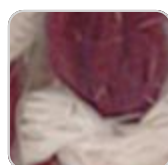

# VONDOM

peach 10355 louro



garnet 10347 louro



anthracite 10354 louro



clay 10346 louro



gray 10353 louro

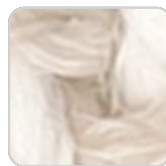

mustard 10345 louro

blue 10352 louro

camel 10344 louro

ocean 10351 louro

cream 10343 louro

Group 2. Tejido suave y versatil que presenta un color neutro de base que facilita su integracion con diversos colores y tejidos.

## Ambients

---

