

Colección Mari-Sol / Mari-Sol Collection Instrucciones para montaje / Assembling instructions

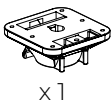
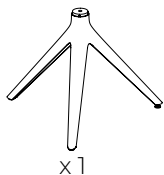

Soporte Abatible
Folding Mechanism

! Tuerca Autoblocante M 10
M 10 Self-locking Nut

Varilla Roscada M 10
M 10 Threaded Rod

Tubo
Cylindrical Tube

Base
Base

! Tuerca con Collar M10
Llave Hexagonal Nº 17
M 10 Flange Nut
Nº 17 Hexagonal Wrench

Soporte Abatible
Folding Mechanism

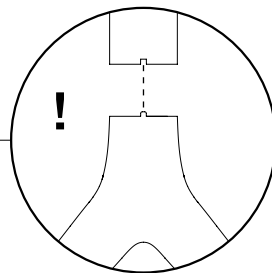
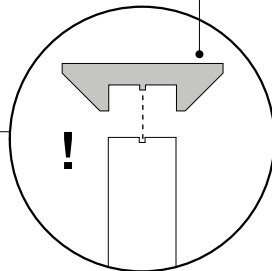

Pata de Nivelación
Leveling leg piece

ASSEMBLY



Llave Allen N° 4
N° 4 Allen Key



M6 x 18 mm
M6 x 18 mm
x 6

Posiciones de los Tornillos en Tableros Cuadrados y Redondos
Screw Insertions in Square and Round Table Top

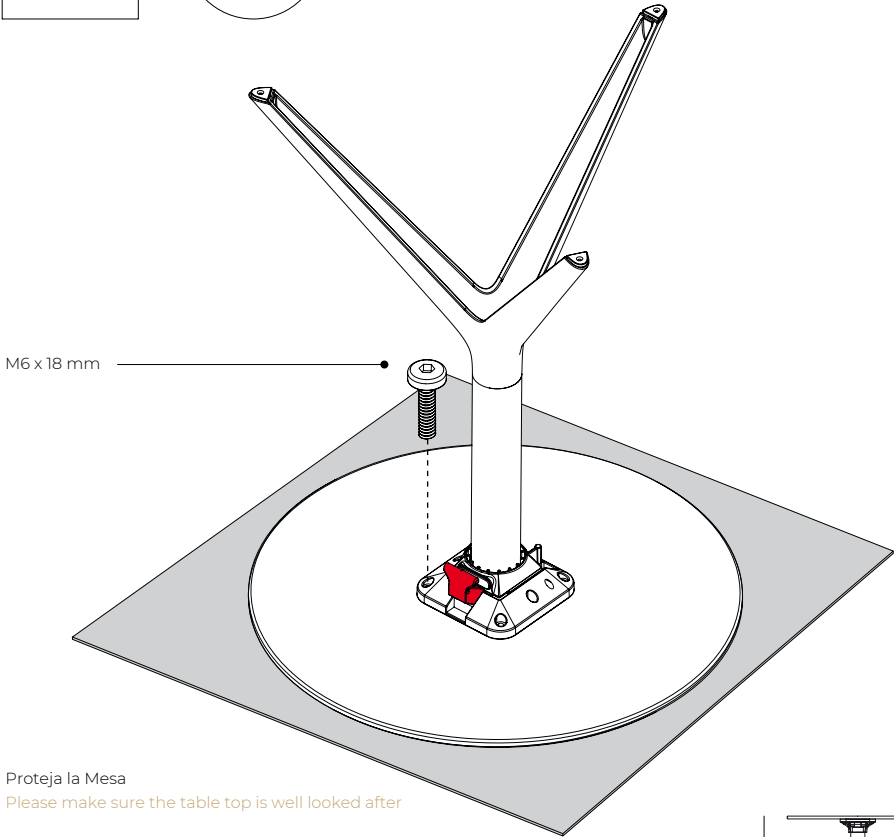
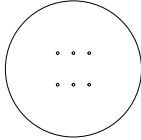
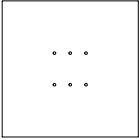

! Proteja la Mesa
Please make sure the table top is well looked after

50 cm
19 3/4"



65009T

73 cm
28 3/4"

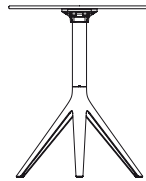

65010T

105 cm
41 3/4"

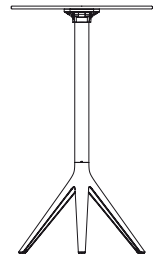

65011T