

Vases nano planter ø18x15

by JM Ferrero

VASES Collection, is made up of flowerpots, furniture and lighting designed by the Valencian designer JM Ferrero. It's shapes were inspired by diamond cutting, producing pieces of clear-cut shapes and great style, creating a big visual impact.



Info

Description

Pot made of polyethylene resin by rotational moulding. 100% Recyclable. Item suitable for indoor and outdoor use. Available in different finishes.

Weight: 0.4 Kg

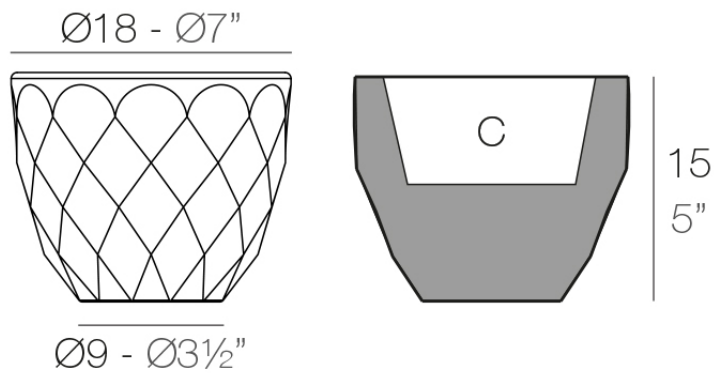

VASES Nano $\text{Ø}18 \times 15$ cm

VASES Nano $\text{Ø}7'' \times 5''$

C = 1 L

C = $\frac{1}{4}$ gal

Finishes

finishes

Basic

Ref. 47018A



white 2001



black 2002



ecru 2003



tortora 2004



gray 2005



anthracite 2006



brown 2008



garnet 2015



green 2016



cream 2017



blue 2018



camel 2020



clay 2022



ecru granite



cream granite



ice 2101

Matt Polyethylene

Lacquered

Ref. 47018F

VONDOM



white 3101



black 3102



ecru 3103



tortora 3104



gray 3105



anthracite 3106



garnet 3113



green 3116



cream 3117



blue 3118



brown 3125

Lacquered Polyethylene

lighting

Led – White
Ref. 47018W

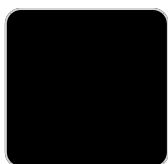

white 201

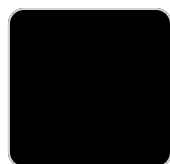

gray 2005

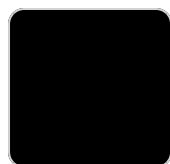

black 2002

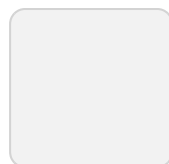

ice 2101

White internally lit unit with LED technology. Available only in matte ice white finish.

Ambients

