

Vases table ø60x74

by JM Ferrero

VASES Collection, is made up of flowerpots, furniture and lighting designed by the Valencian designer JM Ferrero. It's shapes were inspired by diamond cutting, producing pieces of clear-cut shapes and great style, creating a big visual impact.



Info

Description

Made of polyethylene resin by rotational moulding. 100% Recyclable. Item suitable for indoor and outdoor use. Available in different finishes.

Weight: 5.92 Kg

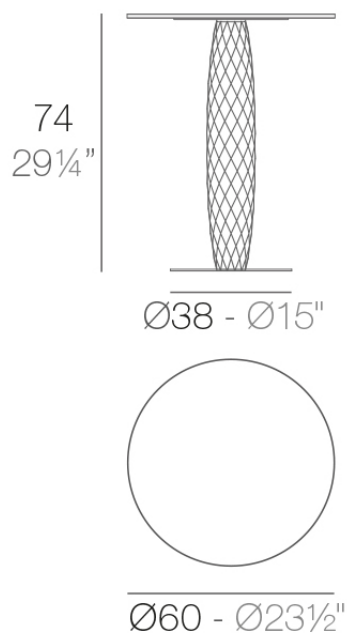

VASES Mesa Redonda Ø60
VASES Round Dining Table Ø23 1/2"

Finishes

finishes

Basic

Ref. 47073



white 2001



black 2002



ecru 2003



gray 2005



tortora 2004



anthracite 2006



red



brown 2008

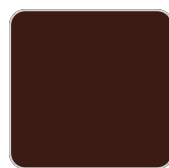

garnet 2015

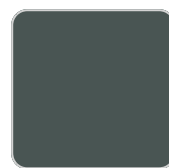

green 2016



cream 2017



blue 2018

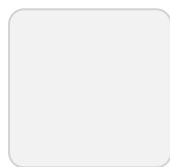

ice 2101



khaki



beige

Matt Polyethylene

Lacquered

Ref. 47073F



white 3101



black 3102



ecru 3103



tortora 3104



gray 3105

VONDOM



anthracite 3106



garnet 3113



green 3116



cream 3117



blue 3118



brown 3125

Lacquered Polyethylene

tabletops

HPL Solid Core Top
Ref. VVAR03006

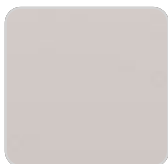

ecru



tortora



smoked

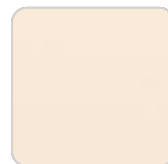

cream



garnet



brown



green



blue



anthracite



white stone



ecru stone



tortora stone

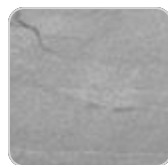

gray stone



black stone

HPL Black Edge Top
Ref. VVAR03006

VONDOM



white(black edge)

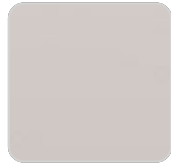

ecru(black edge)



black(black edge)

