

Tablet lounge chair

by Ramón Esteve

The outdoor sofa Tablet collection, designed by Ramon Esteve for Vondom, links new technologies and flexibility to the versatility of a sectional composition, creating a program based on the duality, identity and integration. Its character blends with the space and adapts itself to it.



Info

Description

Furniture made of flexible polyurethane injected cold. This material possesses a high resilience and durability.

The flexible polyurethane foam has an open cellular structure, it is a very elastic material. It hinders the growth of fungi and bacteria.

Weight: 42.76 Kg

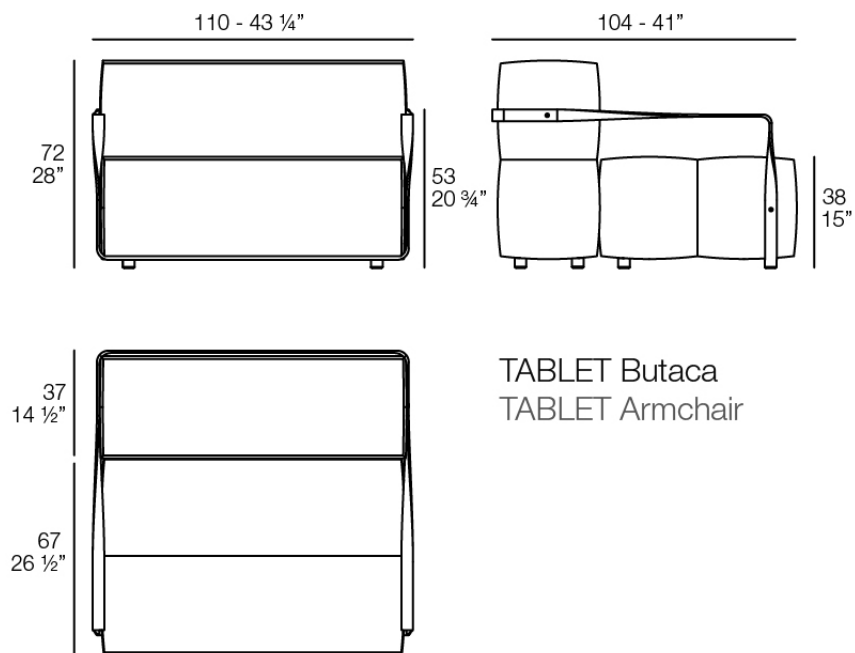

Finishes

finishes

Polyurethane

Ref. 54319

Furniture made of flexible polyurethane injected cold. This material possesses a high resilience and durability.

estructura

Aluminium

Ref. VVAR03085



white



anthracite



black

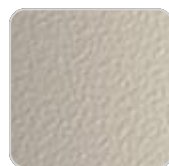

cream



ecru



tortora



garnet



brown



smoked



green



blue

Ref. VVAR03085

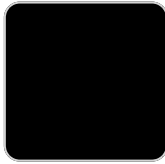

gray

fabric

GETARIA

Ref. 54214T



emerald 10016
getaria



pearl 10006 getaria



green 10053 getaria



black 10044 getaria



white 10041 getaria



gallant 10025 getaria

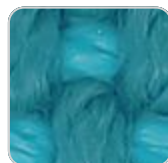

aquamarine 10003
getaria



brown 10050 getaria



anthracite 10043
getaria



moon 10040 getaria



blue 10024 getaria



niord 10015 getaria



oversea 10002 getaria



tortora 10048 getaria



gray 10042 getaria



terra 10039 getaria



ocean 10023 getaria

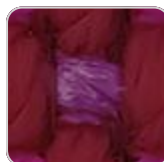

aphrodite 10013
getaria



cream 10047 getaria



iceberg 10037 getaria

VONDOM



granite 10008 getaria



garnet 10046 getaria



camel 10033 getaria

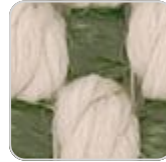

oasis 10007 getaria

Group 2. Premium high density 100% acrylic fabric, available in a wide range of colors.

ZUMAIA

Ref. 54214T



garnet 10202 zumaia



cream 10201 zumaia



black 10205 zumaia



white 10200 zumaia



green 10204 zumaia



blue 10203 zumaia

Group 2. Elegant 100% acrylic fabric, with a soft terry, pleasant to the touch and a unique color combination.

SUANCES

Ref. 54214T



camel 10304 suances



ecru 10301 suances



olive 10317 suances



blue 10312 suances



jade 10309 suances

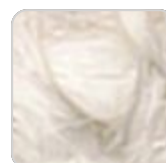
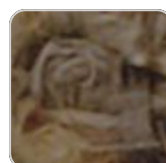
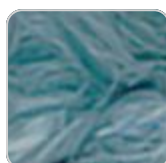
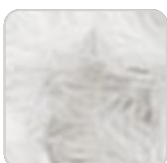

VONDOM

white 10300 suances



black 10315 suances

peach 10316 suances



green 10310 suances

ocean 10311 suances



garnet 10307 suances

brown 10308 suances



tortora 10302 suances

cream 10303 suances



anthracite 10314 suances



clay 10306 suances



gray 10313 suances



mustard 10305 suances

Group 2. Bocol fabric, which stands out for its warmth and softness, with matching colors that add depth and elegance.

RIBADEO

Ref. 54214T



peach 10335 ribadeo



green 10330 ribadeo



garnet 10327 ribadeo



tortora 10322 ribadeo



jade 10329 ribadeo



clay 10326 ribadeo



ecru 10321 ribadeo



mint 10337 ribadeo



anthracite 10334 ribadeo



brown 10328 ribadeo



mustard 10325 ribadeo



white 10320 ribadeo



olive 10336 ribadeo



gray 10333 ribadeo



camel 10324 ribadeo

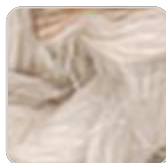

blue 10332 ribadeo

cream 10323 ribadeo

ocean 10331 ribadeo

Group 2. Soft fabric with marbled yarns of different thicknesses that create a rich and visually interesting texture. Its Linen look adds a touch of natural style.

LOURO

Ref. 54214T



olive 10356 louro



peach 10355 louro



brown 10348 louro



garnet 10347 louro

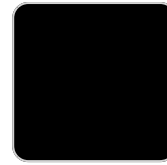

white



anthracite 10354 louro



clay 10346 louro



gray 10353 louro



mustard 10345 louro

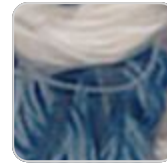

blue 10352 louro



camel 10344 louro



ocean 10351 louro

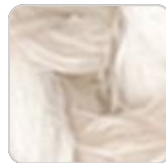

cream 10343 louro

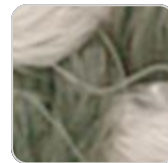

green 10350 louro

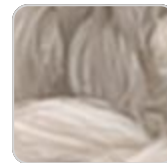

tortora 10342 louro



jade 10349 louro

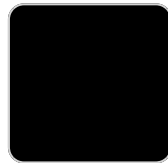

ecru

Group 2. Soft and versatile fabric, which presents a neutral base color that makes it easy to combine with different colors and fabrics.

Ambients

