

The factory lamp s

by Ramón Esteve



Info

Description

Designer lamp. The deployed mesh is made from aluminum, and the inner lighting is made out of polyethylene resin manufactured by rotational molding. Suitable for an interior and an outdoor use. Available in various finishes.

Weight: 3.99 Kg

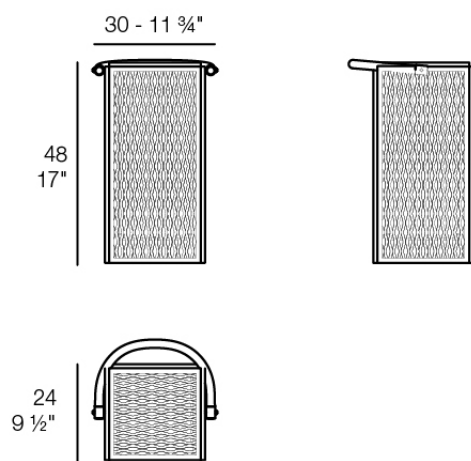

THE FACTORY Lámpara 30 x 24 x 48
THE FACTORY Puff S 11 3/4 x 9 1/2 x 19"

Finishes

lighting

LED RGBW – Battery

Ref. 54612Y

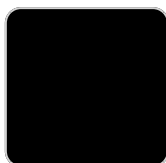

white

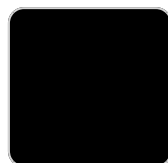

gray

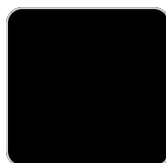

anthracite

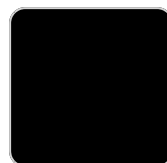

black

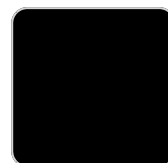

cream

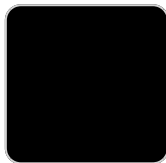

ecru

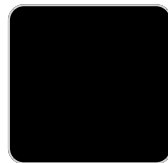

tortora

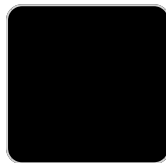

garnet

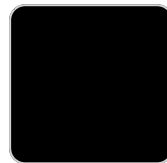

brown

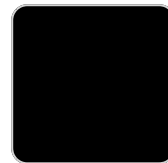

smoked

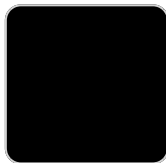

green

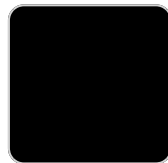

blue

Unit with internal lighting with battery-powered RGBW LED technology. Includes charger and remote control for switching colors and charger. Available only in matte ice white finish.

LED RGBW DMX – Battery

Ref. 54612DY

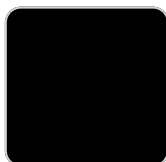

white

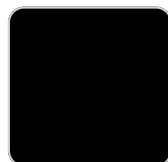

gray

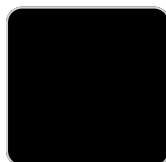

anthracite



black

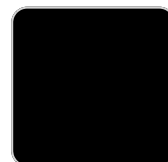

cream

VONDOM

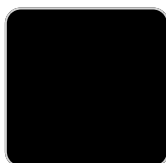

ecru

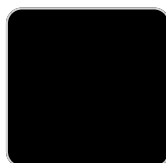

tortora

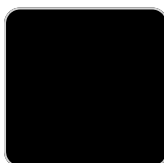

garnet

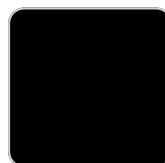

brown

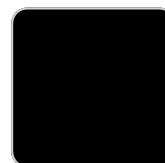

smoked

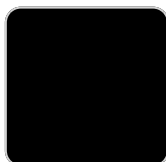

green

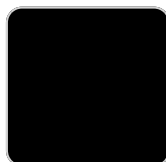

blue

Unit with internal lighting with RGBW LED technology and remote control unit for switching colors. Also controlled by DMX-1024 (wireless), enabling communication between one or more products simultaneously via the DMX transmitter (not included). There are two options to choose from: Professional XLR DMX and Home WIFI DMX. (Remote control included).

Ambients

