

Hamptons sectional left armrest

by Ramón Esteve

Hamptons, the **new collection of designer outdoor furniture** consists of a set of pieces where a careful selection of fabrics and patterns evoke that “lifestyle” where elegance is perceived in the finest details.



Info

Description

Ramón Esteve has designed an elegant modular sofa with a solid aluminium structure, teak details and polished aluminium legs. Its upholstery, devised for outdoor use,

combines weather resistance with the comfort of an indoor fabric. Available in a varied colour palette, it is versatile to suit both outdoor and indoor spaces.

Weight: 27.46 Kg

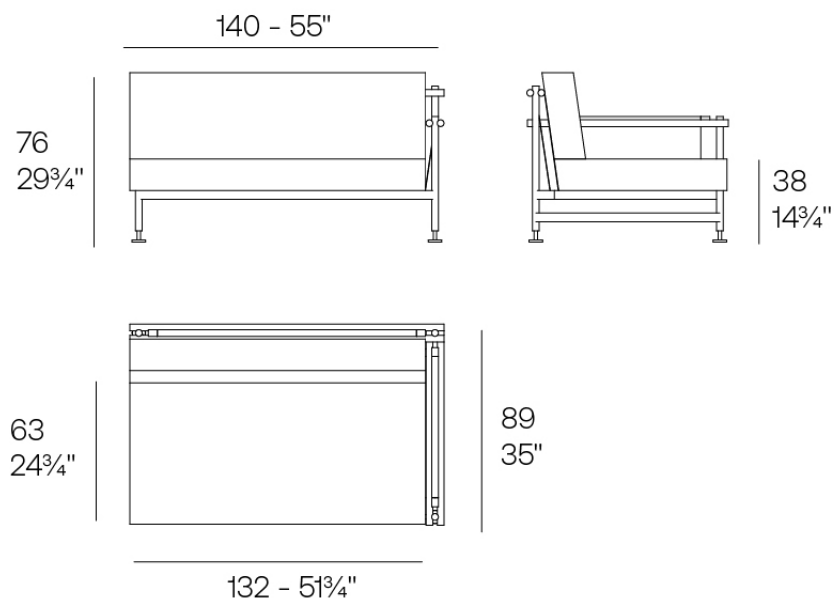

HAMPTONS Módulo Izquierdo
HAMPTONS Left Section

Finishes

finishes

Aluminium
Ref. 54803



white



gray



anthracite



black

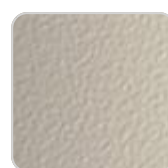

cream



ecru



tortora



garnet



brown



smoked



green



blue

Lacquered aluminium profile.

fabric

BAIONA
Ref. 54801CO



VONDOM

camel 10104 baiona



gray 10113 baiona



cream 10103 baiona



blue 10112 baiona



tortora 10102 baiona

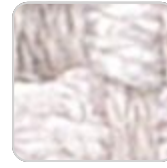

ocean 10111 baiona



green 10110 baiona



ecru 10101 baiona

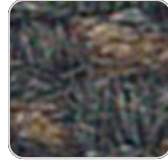

jade 10109 baiona



white 10100 baiona

brown 10108 baiona

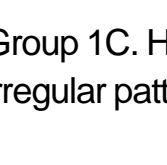

garnet 10107 baiona

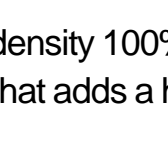

black 10114 baiona

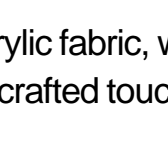

clay 10106 baiona

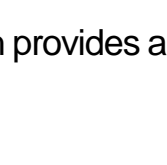

Group 1C. High density 100% acrylic fabric, which provides a solid feel. It has an irregular pattern that adds a handcrafted touch.

CALELLA

Ref. 54801CO



jade 10126 calella



clay 10125 calella



mustard 10124 calella



cream 10123 calella



tortora 10122 calella



ecru 10121 calella



anthracite 10129
calella



white 10120 calella



gray 10128 calella



blue 10127 calella

Group 1C. PFAS-free 100% acrylic fabric with a rich and unusual texture and an exceptional softness, which enhances the comfort of the furniture.

FISTERRA

Ref. 54801CO

VONDOM



cream 10132 fisterra



white 10130 fisterra



ecru 10131 fisterra



tortora 10135 fisterra



camel 10134 fisterra



peach 10146 fisterra



clay 10137 fisterra



garnet 10138 fisterra



brown 10136 fisterra



olive 10145 fisterra



jade 10139 fisterra



green 10140 fisterra



ocean 10141 fisterra



blue 10142 fisterra



gray 10143 fisterra



anthracite 10144
fisterra



black 10147 fisterra

Group 1C. 100% acrylic fabric, with a distinctive irregular marbled pattern and a soft feel.

AROUSA Ref. 54801CO



tortora 1209 arousa



camel 1230 arousa



clay 1231 arousa



brown 1214 arousa

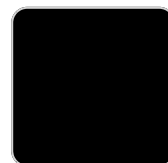

jade 1235 arousa



gray 1208 arousa



anthracite 1210
arousa

VONDOM

Group 1B. Soft outdoor fabric with shiny finish.

LLANES

Ref. 54801TEL

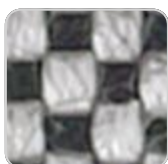

anthracite 10183
llanes

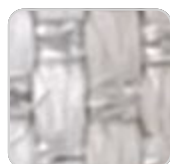

gray 10182 llanes



tortora 10181 llanes

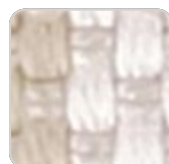

crema 10180 llanes

Group 3A.

ROSES

Ref. 54801TEL



cream 10400 roses

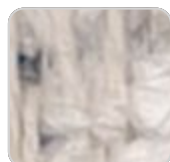

blue 10405 roses

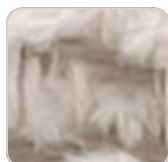

tortora 10404 roses

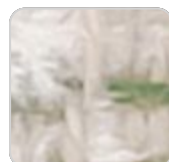

green 10403 roses

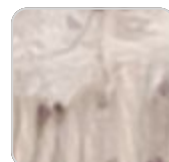

garnet 10402 roses

Group 3A.

Ambients

