

Luna planter ø60x41cm

by Ramón Esteve

Luna channels the revolutionary spirit of icons such as Verner Panton and Joe Colombo. With its use of avant-garde materials and bold forms, Luna is an ode to the democratisation of design, blending functionality, striking aesthetics and a timeless elegance that redefines sophistication in contemporary furniture.



Info

Description

Weight: 6.5 Kg

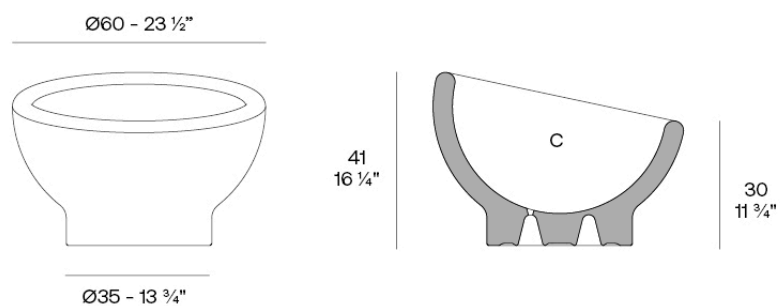

Luna. Macetero $\text{Ø}60$ cm
Luna. Planter $23 \frac{1}{2}"$
54856

C = 23 L
C = 6 gal

Finishes

finishes

Basic

Ref. 54856



white 2001



black 2002



ecru 2003



tortora 2004



gray 2005



anthracite 2006



brown 2008



garnet 2015



green 2016



cream 2017



blue 2018



camel 2020



clay 2022



ecru granite



cream granite



ice 2101

Matt Polyethylene

Lacquered

Ref. 54856F

VONDOM



white 3101



black 3102



ecru 3103



tortora 3104



gray 3105



anthracite 3106



garnet 3113



green 3116



cream 3117



blue 3118



camel 3120



clay



brown 3125

Lacquered Polyethylene

plato

Ref. 42743



white 2001

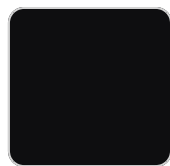

black 2002

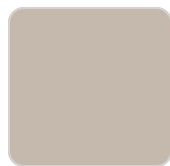

ecru 2003

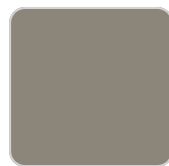

tortora 2004



gray 2005

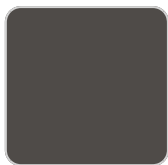

anthracite 2006

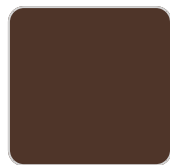

brown 2008

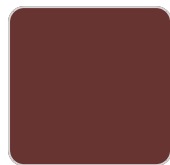

garnet 2015



green 2016



cream 2017



blue 2018

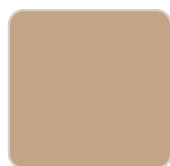

camel 2020

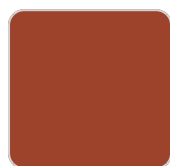

clay 2022

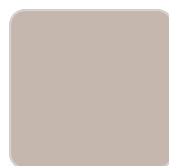

ecru granite



cream granite



ice 2101

