

## Luna lamp 60x60x37

by Ramón Esteve

Luna channels the revolutionary spirit of icons such as Verner Panton and Joe Colombo. With its use of avant-garde materials and bold forms, Luna is an ode to the democratisation of design, blending functionality, striking aesthetics and a timeless elegance that redefines sophistication in contemporary furniture.



## Info

---

### Description

Weight: 6.16 Kg

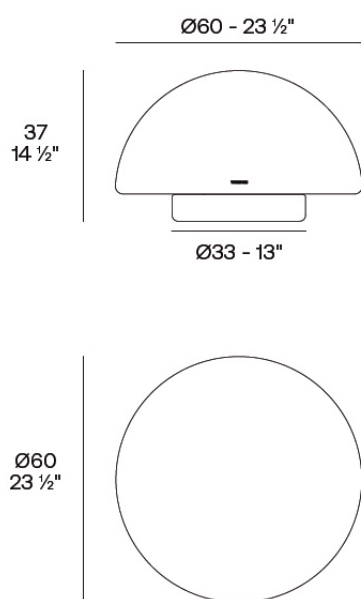

Luna. Lámpara  $\text{Ø}60 \times 37$  cm  
Luna. Lamp  $23 \frac{1}{2} \times 14 \frac{1}{2}"$   
54860

## Finishes

---

### lighting

---

Led – White  
Ref. 54860W



white 2001



black 2002

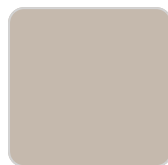

ecru 2003

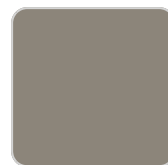

tortora 2004



gray 2005

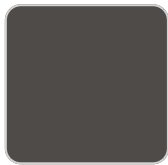

anthracite 2006

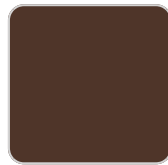

brown 2008

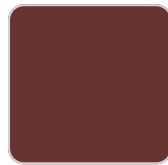

garnet 2015

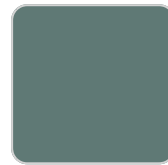

green 2016



cream 2017



blue 2018

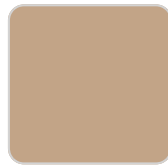

camel 2020

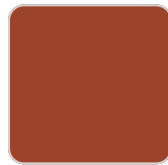

clay 2022



ecru granite



cream granite

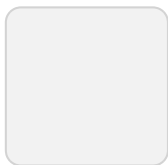

ice 2101

White internally lit unit with LED technology. Available only in matte ice white finish.

LED RGBW – Cable  
Ref. 54860L

# VONDOM



white 2001

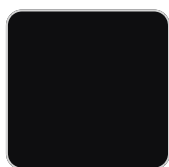

black 2002



ecru 2003



tortora 2004



gray 2005

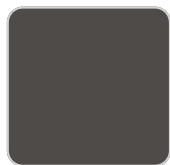

anthracite 2006



brown 2008

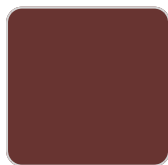

garnet 2015



green 2016



cream 2017



blue 2018

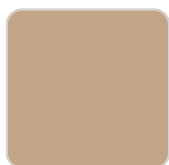

camel 2020



clay 2022



ecru granite



cream granite

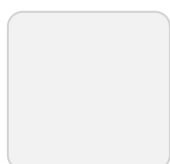

ice 2101

Unit with internal lighting with RGBW LED technology and remote control unit for switching colors. Available only in matte ice white finish. Remote control included.

## LED RGBW DMX – Cable

Ref. 54860D



white 2001



black 2002

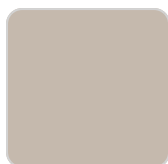

ecru 2003

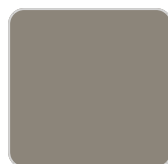

tortora 2004



gray 2005



anthracite 2006

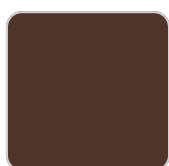

brown 2008

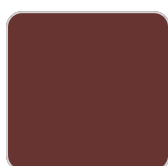

garnet 2015



green 2016

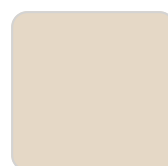

cream 2017

# VONDOM



blue 2018

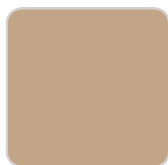

camel 2020

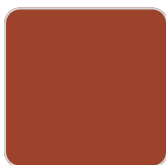

clay 2022



ecru granite



cream granite

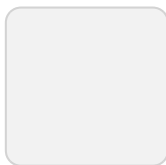

ice 2101

Unit with internal lighting with RGBW LED technology and remote control unit for switching colors. Also controlled by DMX-1024 (wireless), enabling communication between one or more products simultaneously via the DMX transmitter (not included). There are two options to choose from: Professional XLR DMX and Home WIFI DMX. (Remote control included).

Optional battery

## LED RGBW – Battery

Ref. 54860Y



white 2001



black 2002

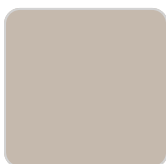

ecru 2003



tortora 2004



gray 2005



anthracite 2006



brown 2008

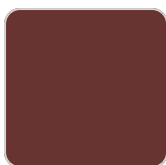

garnet 2015



green 2016

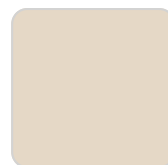

cream 2017



blue 2018

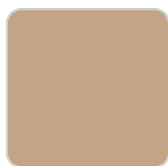

camel 2020

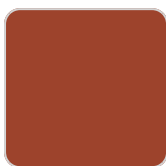

clay 2022



ecru granite



cream granite



ice 2101

Unit with internal lighting with battery-powered RGBW LED technology. Includes charger and remote control for switching colors and charger. Available only in matte ice white finish.

## LED RGBW DMX – Battery Ref. 54860DY



white 2001



black 2002

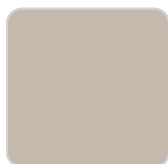

ecru 2003



tortora 2004



gray 2005



anthracite 2006



brown 2008



garnet 2015



green 2016

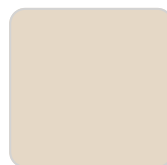

cream 2017



blue 2018

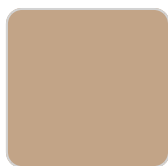

camel 2020

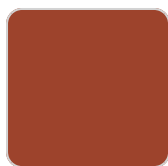

clay 2022



ecru granite



cream granite

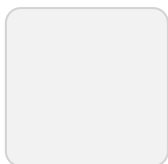

ice 2101

Unit with internal lighting with RGBW LED technology and remote control unit for switching colors. Also controlled by DMX-1024 (wireless), enabling communication between one or more products simultaneously via the DMX transmitter (not included). There are two options to choose from: Professional XLR DMX and Home WIFI DMX. (Remote control included).

