

Incasso armchair

by Archirivolto Design

A highly customizable armchair, from the seat to the base, the color and even the material. Designed by Archirivolto Design.



Info

Description

Made from polypropylene and reinforced with fiberglass manufactured by gas injection. Available in various colors. Suitable for indoor and outdoor use.

Weight: 5.6 Kg

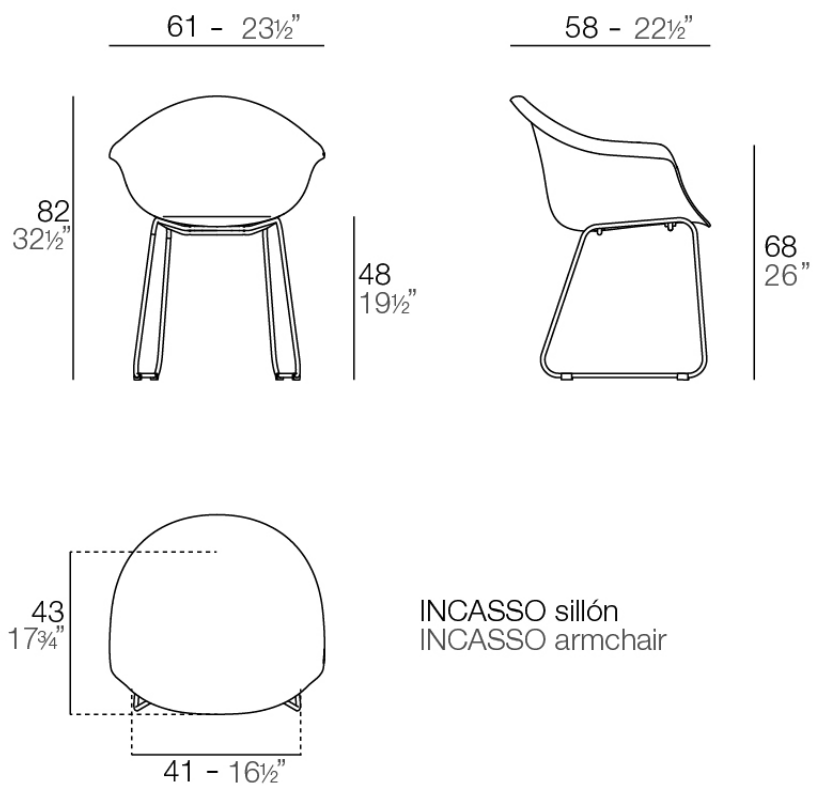

Finishes

finishes

Basic

Ref. 56034



white



black



ecru

Available in various colors

legs

LEGS

Ref. VVAR03438



white 201



black 2002

Ambients

