

Africa counter stool 48x47x85

by Eugeni Quitllet

Vondom's Africa furniture collection, designed by Eugeni Quitllet, captures the essence of simplicity and originality. With pieces that combine beauty and functionality, Africa is ideal for those looking for elegant and comfortable outdoor furniture. "The simplest things are the most original... The most original thing is to be simple...", declares the designer, encapsulating the philosophy of this collection.



Info

Description

Made of gas air moulding injected polypropylene with fiber glass. Stackable. Available in several colors. Item suitable for indoor and outdoor use.

Weight: 4.76 Kg

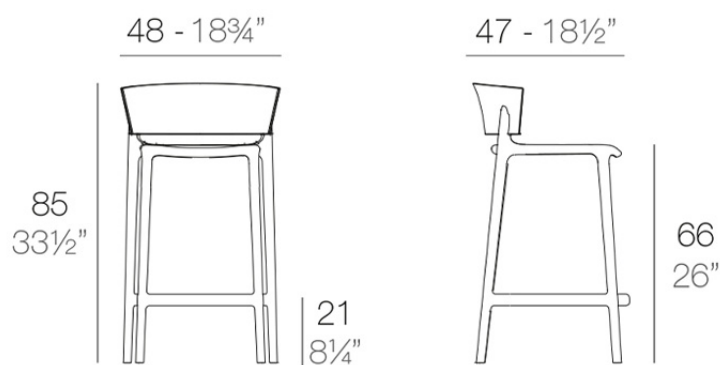

AFRICA Taburete Alto 85
AFRICA Counter Stool 33 1/2"

Finishes

finishes

Basic

Ref. 65030



white



black



ecru

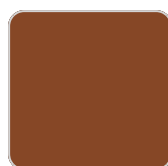

clay

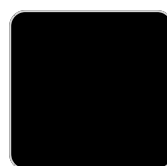

tortora

Available in various colors

tabletops

HPL Black Edge Top

Ref. 66407

HPL black edge

HPL Solid Core Top

Ref. 66407B

HPL solid core

fabric

BAIONA Ref. 65029CO



jade 10109 baiona



white 10100 baiona



brown 10108 baiona



garnet 10107 baiona

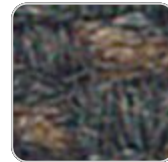

black 10114 baiona



clay 10106 baiona



camel 10104 baiona



gray 10113 baiona

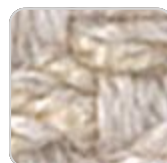

cream 10103 baiona

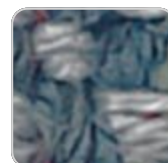

blue 10112 baiona



tortora 10102 baiona

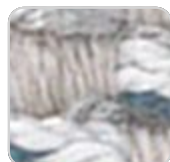

ocean 10111 baiona

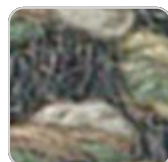

green 10110 baiona

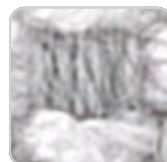

ecru 10101 baiona

Group 1C. High density 100% acrylic fabric, which provides a solid feel. It has an irregular pattern that adds a handcrafted touch.

CALELLA Ref. 65029CO



tortora 10122 calella

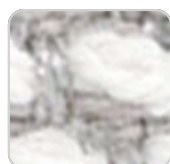

ecru 10121 calella

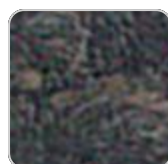

anthracite 10129
calella

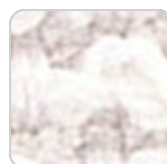

white 10120 calella

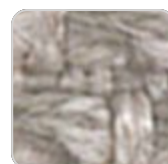

gray 10128 calella



blue 10127 calella



jade 10126 calella



clay 10125 calella



mustard 10124 calella

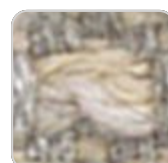

cream 10123 calella

Group 1C. PFAS-free 100% acrylic fabric with a rich and unusual texture and an exceptional softness, which enhances the comfort of the furniture.

FISTERRA

Ref. 65029CO



cream 10132 fisterra



white 10130 fisterra



ecru 10131 fisterra



tortora 10135 fisterra



camel 10134 fisterra



peach 10146 fisterra



clay 10137 fisterra



garnet 10138 fisterra

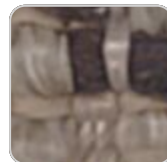

brown 10136 fisterra

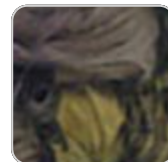

olive 10145 fisterra



jade 10139 fisterra



green 10140 fisterra



ocean 10141 fisterra



blue 10142 fisterra



gray 10143 fisterra



anthracite 10144
fisterra



black 10147 fisterra

Group 1C. 100% acrylic fabric, with a distinctive irregular marbled pattern and a soft feel.

PORTONOVO

Ref. 65029CO

VONDOM



garnet 10157
portonovo



black 10165
portonovo

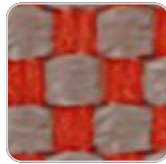

clay 10156 portonovo



anthracite 10164
portonovo



gray 10163 portonovo



mustard 10155
portonovo



blue 10162 portonovo



camel 10154
portonovo



ocean 10161
portonovo



cream 10153
portonovo



green 10160
portonovo



tortora 10152
portonovo



jade 10159 portonovo

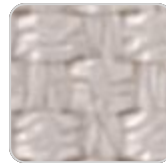

ecru 10151 portonovo

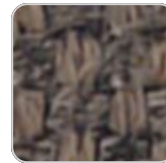

brown 10158
portonovo



white 10150
portonovo

Group 1A. 100% acrylic fabric, with a flat and simple design, which adapts to any decorative style.

ALTEA

Ref. 65029CO



tortora 1102 altea



white 1100 altea



camel 1120 altea



clay 1122 altea



garnet 1106 altea



brown 1104 altea



jade 1125 altea



ocean 1123 altea



gray 1101 altea



anthracite 1124 altea



black 1105 altea

Group 1A. Soft outdoor fabric with leather-like texture.

AROUSA Ref. 65029CO



tortora 1209 arousa



camel 1230 arousa



clay 1231 arousa



brown 1214 arousa

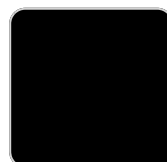

jade 1235 arousa



gray 1208 arousa



anthracite 1210
arousa

Group 1B. Soft outdoor fabric with shiny finish.

Ambients

