

Palm table 60x60 73h

by Eugeni Quitllet

Palm captures the essence of the open air: lightness that breathes and an organic lattice that lets the breeze pass through. Its language is soft, enveloping, and natural—a gesture that dresses outdoor and indoor spaces with equal ease.



Info

Description

Weight: 6.5 Kg

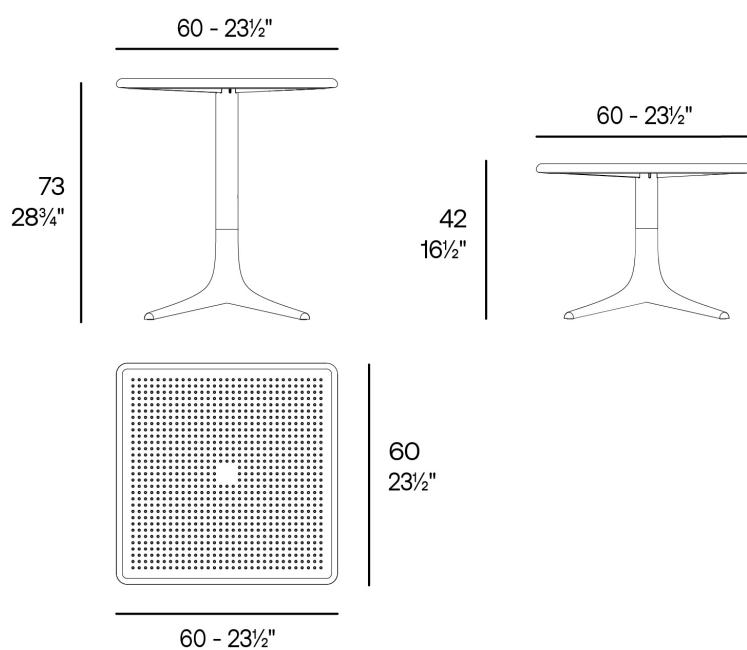

PALM Mesa 60x60
PALM Table 60x60

Finishes

finishes

Basic

Ref. 65068



white



black



ecru

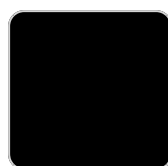

tortora

Available in various colors

