

Tulum coffee table

by Eugeni Quitllet

Tulum, designed by Eugeni Quitllet, is a collection of designer furniture to live freely anywhere in the world.



Info

Description

The coffee table in the collection is characterised by its aluminium structure treated with epoxy paint and precise welding, guaranteeing durability and strength. Its surface is made of Indonesian teak wood

slats, adding a touch of natural elegance.

This table perfectly combines high quality materials with an aesthetic design.

Weight: 14 Kg

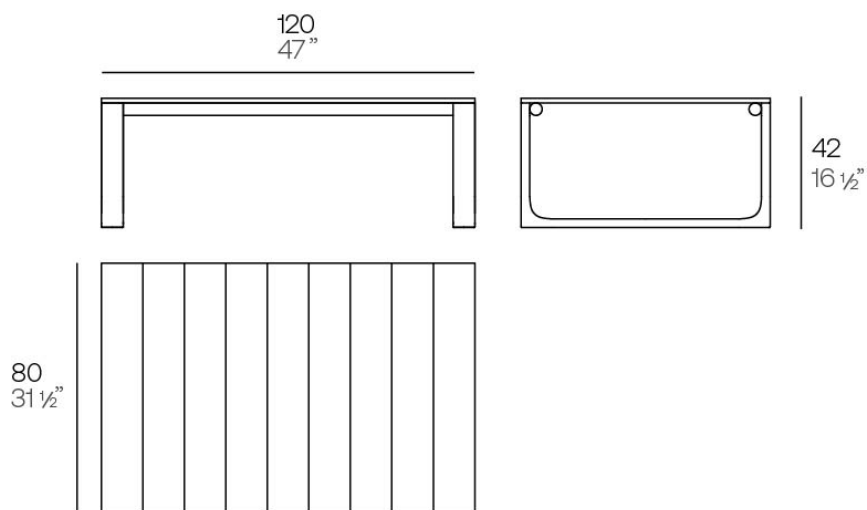

Tulum. Mesa Café
Tulum. Coffee Table
ref. 65074

Finishes

finishes

TEAK FINISH – Natural

Ref. 65074

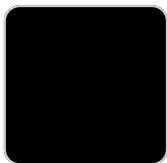

white



gray

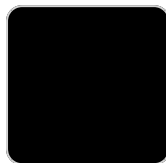

anthracite

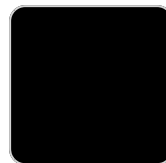

black

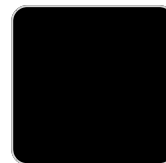

cream

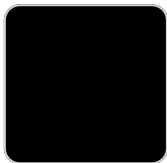

camel



ecu

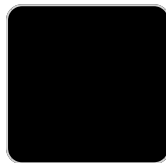

tortora

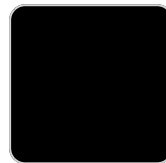

clay

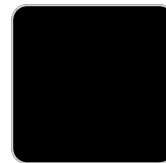

garnet

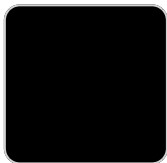

brown



smoked

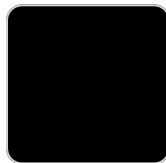

green

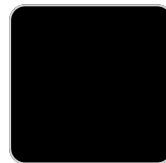

ocean

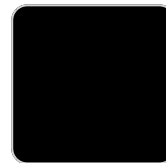

blue

TEAK FINISH – Weathered

Ref. 65074E

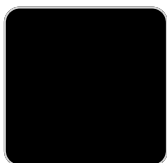

white

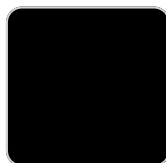

gray

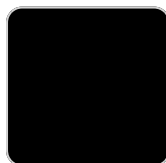

anthracite

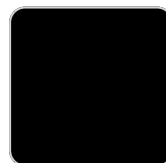

black

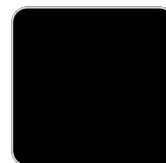

cream

VONDOM



camel

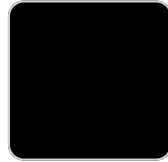

ecru

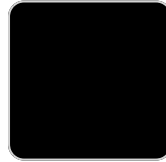

tortora

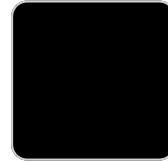

clay

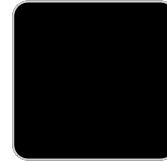

garnet

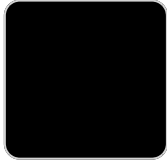

brown



smoked

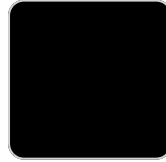

green

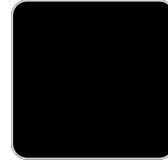

ocean

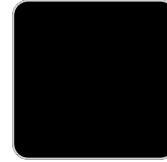

blue

tabletops

Teak wood

Ref. 65074TBL



natural teak



weathered teak

Ambients

