

Milos daybed

by Jean-Marie Massaud

The Milos collection is the fruit of a collaboration between Vondom and renowned French designer Jean-Marie Massaud, combining simplicity and functionality in pieces that stand out for their bold design and comfort. With soft curves and shapes inspired by nature, the outdoor furniture collection offers a unique experience, which is why it has been awarded the prestigious Red Dot 2024 design award.



Info

Description

The Milos collection daybed combines functionality and beauty in perfect harmony. Precision crafted, it features a lacquered aluminium frame that ensures exceptional resistance to outdoor conditions,

while its elegant iroko wood legs add a touch of warmth and sophistication, providing stability and a connection to nature.

Weight: 80.25 Kg

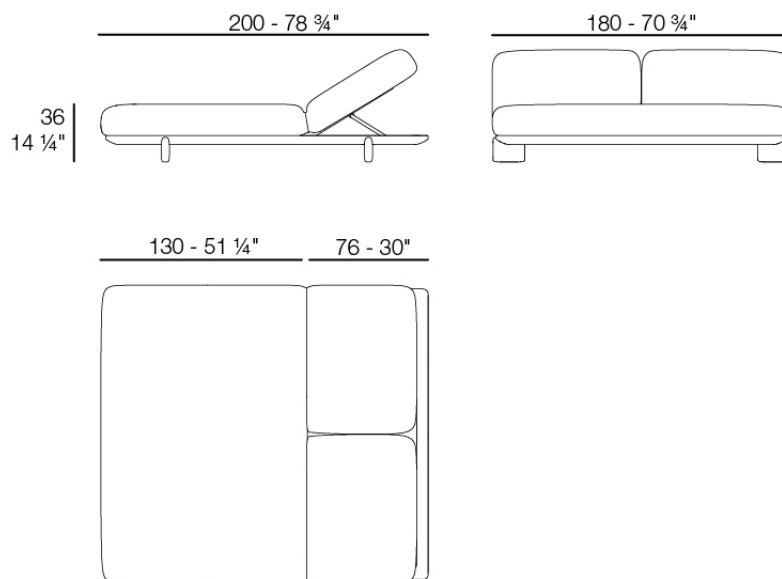

MILOS Daybed
MILOS Daybed
Ref. 70012

Finishes

finishes

Polyurethane

Ref. 70012

Furniture made of flexible polyurethane injected cold. This material possesses a high resilience and durability.

estructura

Ref. 70012AF

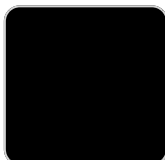

white

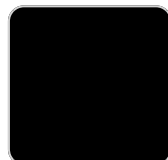

gray

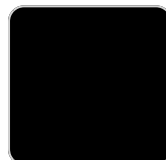

anthracite

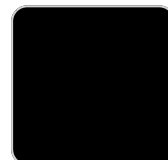

black

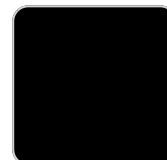

cream

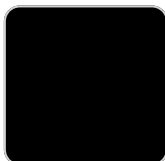

camel

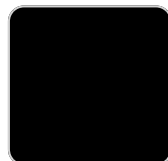

ecru

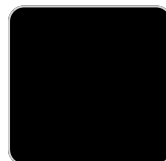

tortora

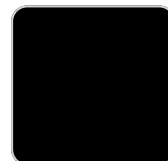

clay

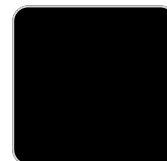

garnet

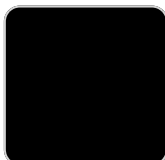

brown

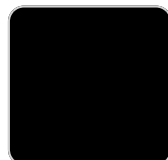

smoked

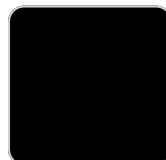

green



ocean

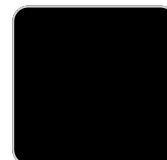

blue

fabric

GETARIA

Ref. 70012CO



emerald 10016
getaria



white 10041 getaria



green 10053 getaria



niord 10015 getaria



moon 10040 getaria



brown 10050 getaria



terra 10039 getaria



aphrodite 10013
getaria



tortora 10048 getaria

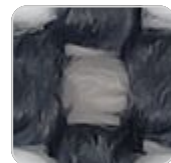

granite 10008 getaria



cream 10047 getaria



iceberg 10037 getaria



oasis 10007 getaria



garnet 10046 getaria



camel 10033 getaria



pearl 10006 getaria



black 10044 getaria



gallant 10025 getaria



blue 10024 getaria



anthracite 10043
getaria



aquamarine 10003
getaria



ocean 10023 getaria



gray 10042 getaria



oversea 10002 getaria

Group 2. Premium high density 100% acrylic fabric, available in a wide range of colors.

ZUMAIA

Ref. 70012CO

VONDOM



black 10205 zumaia



green 10204 zumaia



blue 10203 zumaia



garnet 10202 zumaia



cream 10201 zumaia



white 10200 zumaia

Group 2. Elegant 100% acrylic fabric, with a soft terry, pleasant to the touch and a unique color combination.

SUANCES

Ref. 70012CO



tortora 10302 suances



green 10310 suances



olive 10317 suances

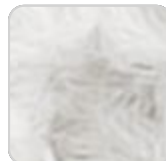

white 10300 suances



jade 10309 suances



brown 10308 suances



peach 10316 suances



garnet 10307 suances



black 10315 suances



clay 10306 suances



anthracite 10314
suances



gray 10313 suances



mustard 10305
suances



blue 10312 suances



camel 10304 suances



ocean 10311 suances

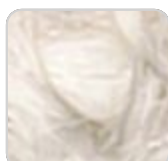

cream 10303 suances

Group 2. Bocle fabric, which stands out for its warmth and softness, with matching

VONDOM

colors that add depth and elegance.

RIBADEO

Ref. 70012CO



white 10320 ribadeo



mint 10337 ribadeo



jade 10329 ribadeo



olive 10336 ribadeo



brown 10328 ribadeo



clay 10326 ribadeo



peach 10335 ribadeo



mustard 10325
ribadeo

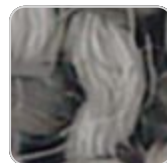

anthracite 10334
ribadeo



camel 10324 ribadeo



gray 10333 ribadeo



blue 10332 ribadeo

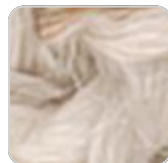

cream 10323 ribadeo



tortora 10322 ribadeo



ocean 10331 ribadeo



ecru 10321 ribadeo



green 10330 ribadeo

Group 2. Soft fabric with marbled yarns of different thicknesses that create a rich and visually interesting texture. Its Linen look adds a touch of natural style.

LOURO

Ref. 70012CO



garnet 10347 louro



peach 10355 louro



clay 10346 louro



anthracite 10354 louro

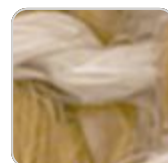

mustard 10345 louro

VONDOM



gray 10353 louro



blue 10352 louro



camel 10344 louro



ocean 10351 louro

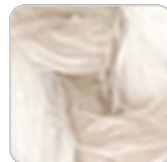

cream 10343 louro



green 10350 louro



tortora 10342 louro

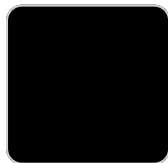

ecru



jade 10349 louro



olive 10356 louro

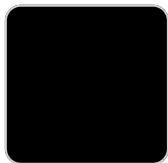

white



brown 10348 louro

Group 2. Soft and versatile fabric, which presents a neutral base color that makes it easy to combine with different colors and fabrics.

Ref. 70012CO

Ambients

