

Marquis hanging planter ø50x26

by JM Ferrero

Marquis, designed by Estudi{H}ac for Vondom, is a planters collection **originating from the inspiration of diamond cutting**. Its polygonal design recalls facets created through cutting. It also **includes a design table lamp**.



Info

Description

Made of polyethylene resin by rotational moulding. 100% Recyclable. Item suitable for indoor and outdoor use. Available in different finishes.

Weight: 4.5 Kg

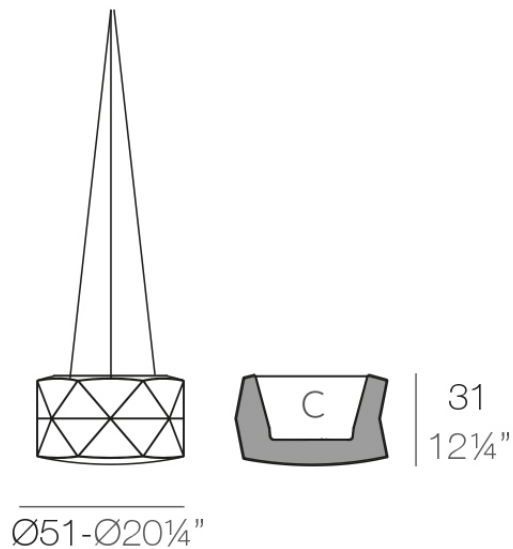

MARQUIS Maceta Ø51x31

C = 3 L x 22 cm

MARQUIS Planter Ø20¼"x12¼"

C = ¾ gal 190

Finishes

finishes

BASIC

Ref. 47086A



white 2001



ecru 2003



tortora 2004



cream 2017



camel 2020



clay 2022



garnet 2015



brown 2008



green 2016



blue 2018



gray 2005



anthracite 2006



black 2002



ecru granite



cream granite



ice 2101

Matt Polyethylene

SELF-WATERING

Ref. 47086R

VONDOM



white 2001



ecru 2003



tortora 2004



cream 2017



camel 2020



clay 2022

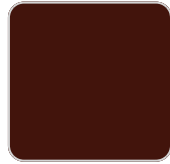

garnet 2015



brown 2008

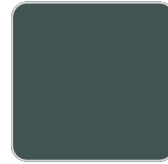

green 2016



blue 2018



gray 2005



anthracite 2006



black 2002



ecru granite



cream granite



ice 2101

Self-watering system included in all planters except those with basic finish

LACQUERED

Ref. 47086F



white 3101



ecru 3103



tortora 3104

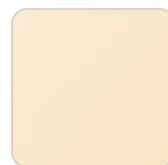

cream 3117



garnet 3113



brown 3125



green 3116



blue 3118



gray 3105



anthracite 3106



black 3102

Lacquered Polyethylene

Ambients

