

FRAME ALUMINIUM TABLE

160x100x74

By Ramon Esteve



FRAME Collection comes from generating serene and timeless shapes using the framework as elementary geometry. The endless possibilities offered by the material using advanced technology, was the motivation to explore the limits. The FRAME section is flared creating pieces of visual lightness while still categorical and resistant. FRAME meets a wide range of needs in any outdoor space thanks to its variety of pieces.

View online: <https://www.vondom.com/products/54240F>

Features

Description

Extruded aluminum with cast lacquered aluminum base. HPL Table top ó Dekton Table top. Item suitable for indoor and outdoor use. HPL Table top.

Weight

32.65 Kg

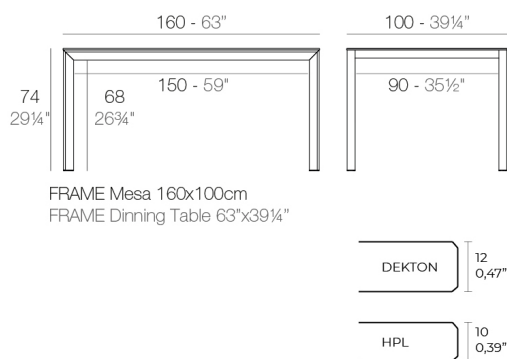

FINISHES

LACQUERED

Ref. 54240F

Lacquered aluminium profile.

- WHITE
- BLACK
- ECRU

LACQUERED + HPL FULL WHITE

Ref. 54240FB

Lacquered aluminium profile.

- WHITE

LACQUERED + DEKTON

Ref. 54240FM

Lacquered aluminium profile.

- KELYA
- ENTZO
- DANAE

