

Quartz dining table ø79

by Ramón Esteve

The Quartz collection of modern chairs and tables, designed by Ramón Esteve for Vondom, has a distinctive appearance characterized by **vertical lines** and triangular profiles. One of its outstanding features is the line of one of its vertices, which creates an impression of lightness, making the furniture seem almost weightless, while still ensuring robust functionality.

Crafted with high quality materials, this modern collection of chairs and tables is perfect for enhancing both indoor and outdoor spaces. With its elegant design and durability, the Quartz collection blends seamlessly into any environment, striking the perfect balance between form and function.



Info

Description

Weight: 9.7 Kg

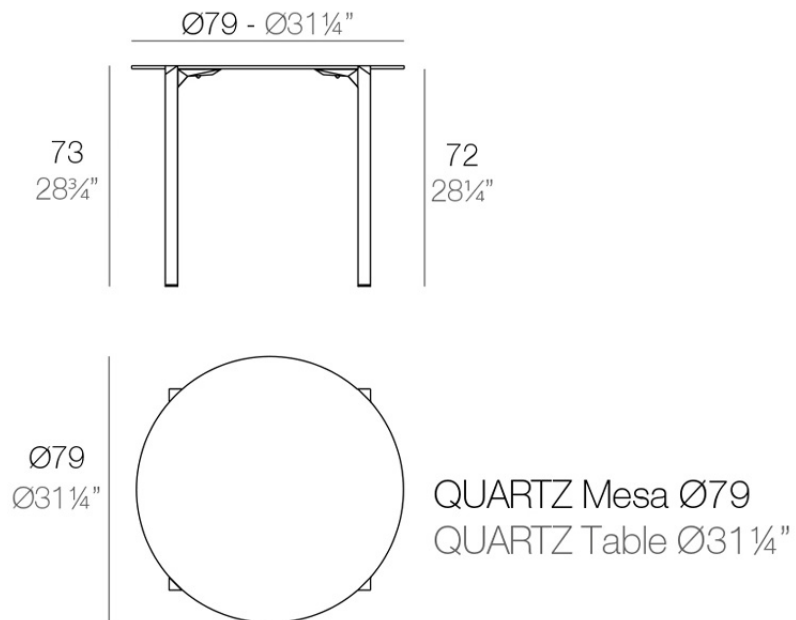

Finishes

tabletops

HPL Black Edge Top

Ref. 54218



white



black

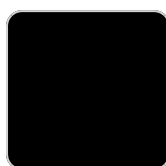

ecru

HPL black edge

HPL Solid Core Top

Ref. 54218B

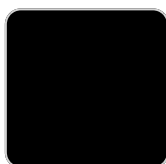

white

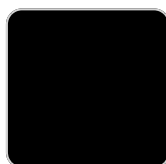

black

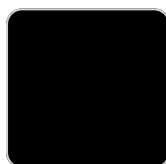

ecru

HPL solid core

tabletops

Ref. VVAR02458

VONDOM



white (white edge)



ecru



tortora



smoked



cream

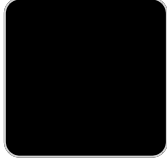

camel

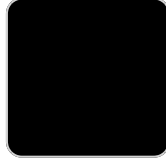

clay

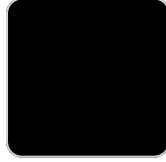

garnet



brown



green

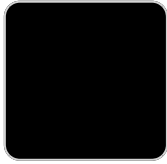

ocean

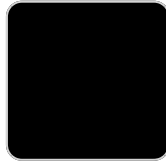

blue

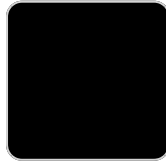

gray

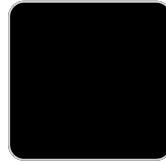

anthracite

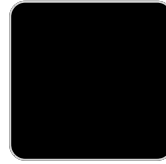

white stone

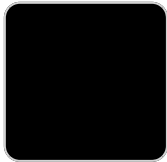

cream stone

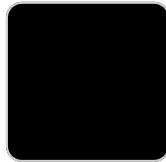

ecru stone

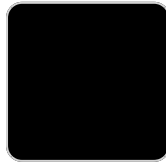

tortora stone

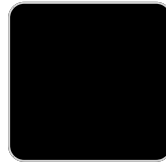

green stone

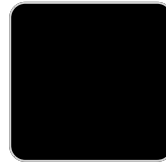

gray stone

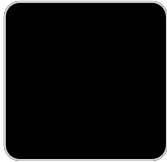

black stone

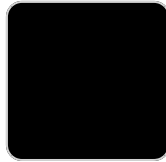

oak1

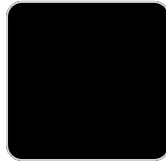

oak2

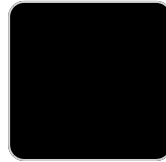

walnut

HPL Black Edge Top

Ref. VVAR02458



white(black edge)



ecru(black edge)



black(black edge)

