

## Hamptons sectional left armrest

by Ramón Esteve

The **new Hamptons collection** features stunning designer outdoor furniture from Ramón Esteve, meticulously crafted to enhance the outdoor spaces with a lifestyle defined by timeless elegance and sophistication. Through a careful selection of premium fabrics, textures and intricate patterns, each piece invites you to indulge in the finer details of patio decor and outdoor living.

This collection embodies a sense of sophistication and exclusivity that reflects the essence of luxury living, ensuring that every aspect of its design enhances the ambiance of outdoor environments with effortless style, comfort and enduring quality.



## Info

---

### Description

Ramón Esteve has designed an elegant modular sofa with a solid aluminium structure, teak details and polished aluminium legs. Its upholstery, devised for outdoor use,

combines weather resistance with the comfort of an indoor fabric. Available in a varied colour palette, it is versatile to suit both outdoor and indoor spaces.

Weight: 27.46 Kg

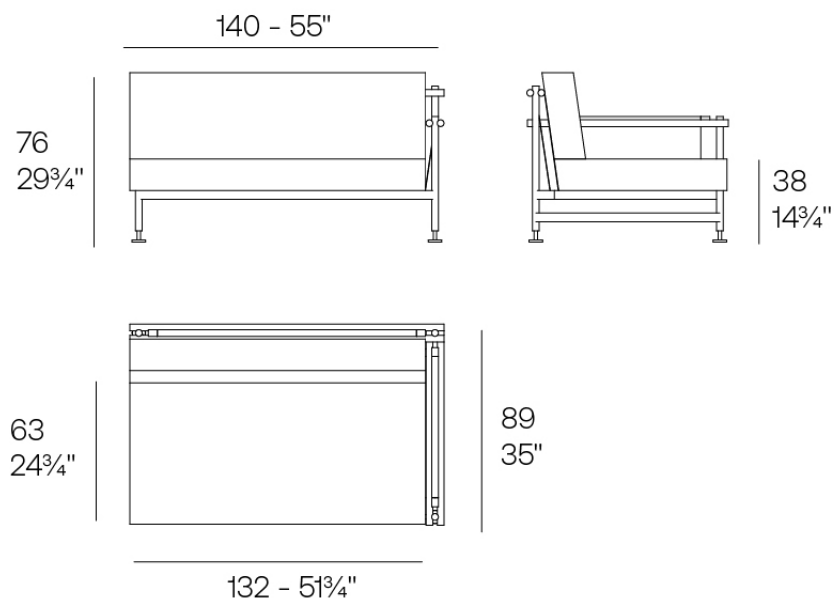

HAMPTONS Módulo Izquierdo  
HAMPTONS Left Section

## Finishes

---

### finishes

---

Aluminium  
Ref. 54803



white



smoked



ecru



tortora



cream



garnet



brown



green



blue



gray



anthracite



black

Lacquered aluminium profile.

### fabric

---

BAIONA  
Ref. 54801CO



# VONDOM

black 10114 baiona



clay 10106 baiona



gray 10113 baiona



camel 10104 baiona



blue 10112 baiona



cream 10103 baiona



ocean 10111 baiona



tortora 10102 baiona



green 10110 baiona



ecru 10101 baiona

jade 10109 baiona

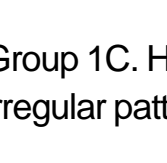

white 10100 baiona

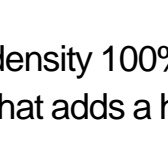

brown 10108 baiona

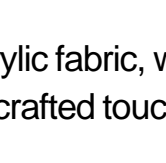

garnet 10107 baiona

Group 1C. High density 100% acrylic fabric, which provides a solid feel. It has an irregular pattern that adds a handcrafted touch.

## CALELLA

Ref. 54801CO



blue 10127 calella



jade 10126 calella



clay 10125 calella



mustard 10124 calella



cream 10123 calella



tortora 10122 calella



anthracite 10129  
calella



ecru 10121 calella



gray 10128 calella

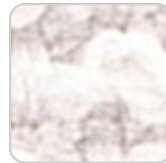

white 10120 calella

Group 1C. PFAS-free 100% acrylic fabric with a rich and unusual texture and an exceptional softness, which enhances the comfort of the furniture.

## FISTERRA

Ref. 54801CO

# VONDOM



cream 10132 fisterra



white 10130 fisterra



ecru 10131 fisterra



tortora 10135 fisterra



camel 10134 fisterra



peach 10146 fisterra



clay 10137 fisterra



garnet 10138 fisterra



brown 10136 fisterra



olive 10145 fisterra



jade 10139 fisterra



green 10140 fisterra



ocean 10141 fisterra



blue 10142 fisterra



gray 10143 fisterra



anthracite 10144  
fisterra



black 10147 fisterra

Group 1C. 100% acrylic fabric, with a distinctive irregular marbled pattern and a soft feel.

## AROUSA Ref. 54801CO



tortora 1209 arousa



camel 1230 arousa



clay 1231 arousa



brown 1214 arousa

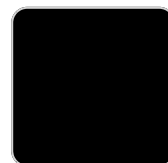

jade 1235 arousa



gray 1208 arousa



anthracite 1210  
arousa

# VONDOM

Group 1B. Soft outdoor fabric with shiny finish.

## LLANES

Ref. 54801TEL

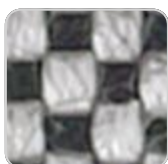

anthracite 10183  
llanes

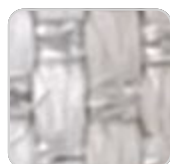

gray 10182 llanes



tortora 10181 llanes

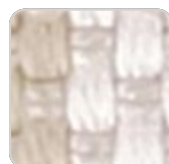

crema 10180 llanes

Group 3A.

## ROSES

Ref. 54801TEL



garnet 10402 roses



cream 10400 roses

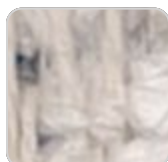

blue 10405 roses



tortora 10404 roses

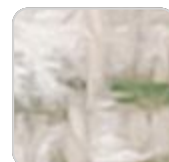

green 10403 roses

Group 3A.

## Ambients

---

