

## Hamptons low tables

by Ramón Esteve

The **new Hamptons collection** features stunning **designer outdoor furniture** from Ramón Esteve, meticulously crafted to enhance the outdoor spaces with a lifestyle defined by timeless elegance and sophistication. Through a careful selection of premium fabrics, textures and intricate patterns, each piece invites you to indulge in the finer details of patio decor and outdoor living.

This collection embodies a sense of sophistication and exclusivity that reflects the essence of luxury living, ensuring that every aspect of its design enhances the ambiance of outdoor environments with effortless style, comfort and enduring quality.



## Info

---

### Description

The low table in the collection stands out for its aluminium structure, which makes it lightweight and sturdy, ideal for outdoor use. The surface is made of HPL sheets, a durable and easy to maintain material.

The polished aluminium legs add a touch of elegance and shine. Available in a wide variety of colours for both the aluminium frame and the HPL surface.

Weight: 34.74 Kg

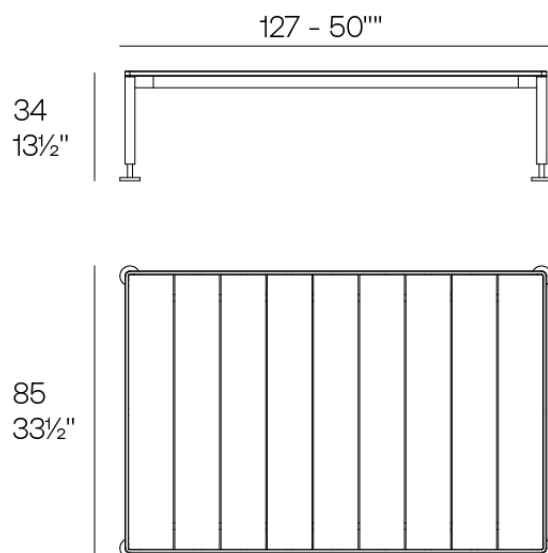

HAMPTONS Mesa Baja 127x85x33 1/2  
HAMPTONS Low Table 50"x33 1/2"x13 1/2"

## Finishes

---

### finishes

---

HPL Solid Core Top  
Ref. 54810



white

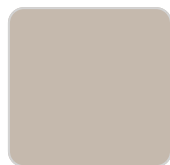

ecru



smoked



tortora



cream

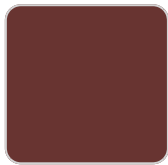

garnet

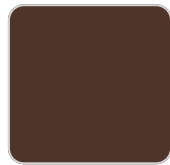

brown



green



blue



gray

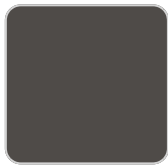

anthracite

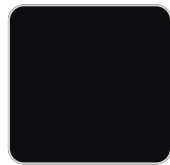

black

Lacquered aluminium profile.

### tabletops

---

HPL Solid Core Top  
Ref. 54810CEN

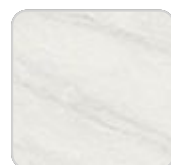

# VONDOM

ecru stone



smoked

tortora stone



oak1

black stone



white (white edge)

gray stone



ecru

white stone



oak2



tortora

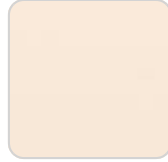

cream



garnet



brown



green



blue

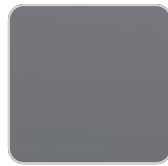

anthracite

## HPL Black Edge Top Ref. 54810CEN



black(black edge)

## Ambients

---

