

Luna lamp 60x60x33

by Ramón Esteve

Luna channels the revolutionary spirit of design icons such as Verner Panton and Joe Colombo, known for their influential contributions to outdoor and contemporary furniture. Inspired by their pioneering work, the Luna collection fuses avant-garde materials with bold forms to epitomize the democratization of outdoor furniture, seamlessly blending functionality with striking aesthetics and a timeless elegance that redefines sophistication in contemporary furniture.



Info

Description

Weight: 5.3 Kg

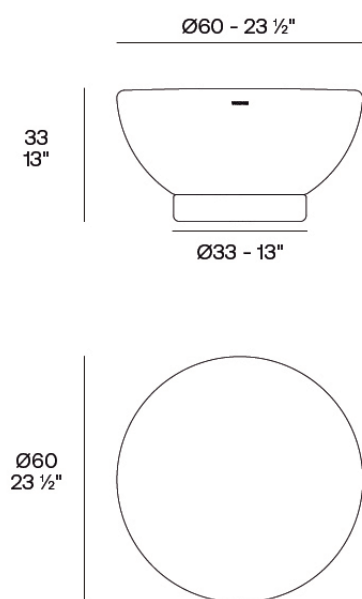

Luna. Lámpara $\text{Ø}60 \times 33$ cm
Luna. Lamp $23 \frac{1}{2} \times 13"$
54858

Finishes

finishes

Basic

Ref. 54858

Matt Polyethylene

lighting

Led – White

Ref. 54858W



white 2001

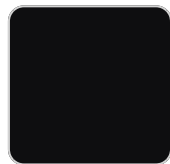

black 2002



ecru 2003

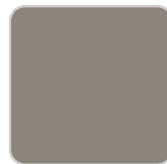

tortora 2004



gray 2005



anthracite 2006

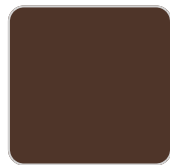

brown 2008

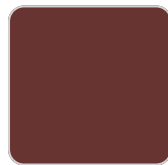

garnet 2015



green 2016



cream 2017



blue 2018

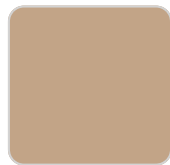

camel 2020

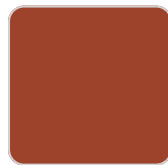

clay 2022



ecru granite



cream granite

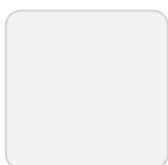

VONDOM

ice 2101

White internally lit unit with LED technology. Available only in matte ice white finish.

LED RGBW – Cable Ref. 54858L



white 2001

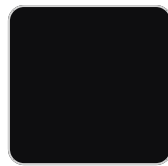

black 2002

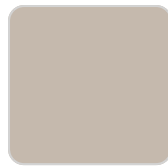

ecru 2003

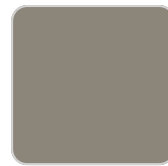

tortora 2004

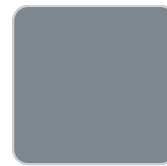

gray 2005

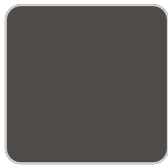

anthracite 2006

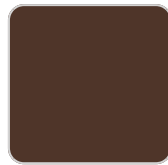

brown 2008

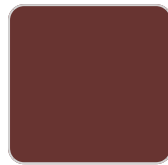

garnet 2015

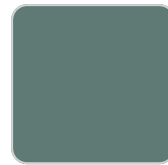

green 2016



cream 2017



blue 2018

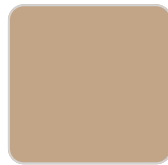

camel 2020

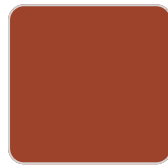

clay 2022

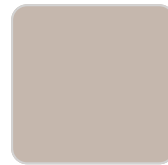

ecru granite



cream granite



ice 2101

Unit with internal lighting with RGBW LED technology and remote control unit for switching colors. Available only in matte ice white finish. Remote control included.

LED RGBW DMX – Cable Ref. 54858D

VONDOM



white 2001

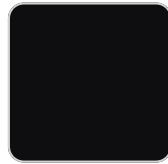

black 2002

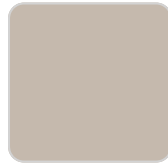

ecru 2003

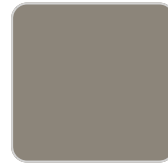

tortora 2004



gray 2005



anthracite 2006

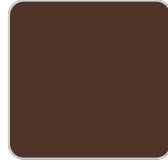

brown 2008

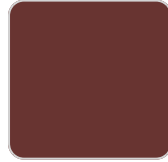

garnet 2015



green 2016



cream 2017



blue 2018



camel 2020



clay 2022

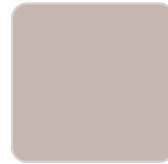

ecru granite



cream granite



ice 2101

Unit with internal lighting with RGBW LED technology and remote control unit for switching colors. Also controlled by DMX-1024 (wireless), enabling communication between one or more products simultaneously via the DMX transmitter (not included). There are two options to choose from: Professional XLR DMX and Home WIFI DMX. (Remote control included).

Optional battery

LED RGBW – Battery

Ref. 54858Y



white 2001

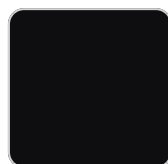

black 2002



ecru 2003

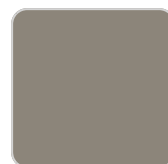

tortora 2004



gray 2005

VONDOM

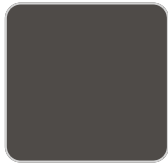

anthracite 2006

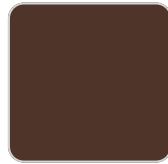

brown 2008

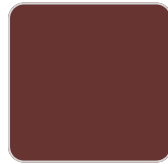

garnet 2015

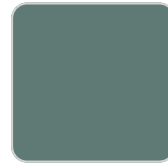

green 2016



cream 2017



blue 2018

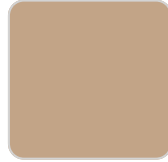

camel 2020

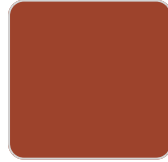

clay 2022



ecru granite



cream granite



ice 2101

Unit with internal lighting with battery-powered RGBW LED technology. Includes charger and remote control for switching colors and charger. Available only in matte ice white finish.

LED RGBW DMX – Battery Ref. 54858DY



white 2001

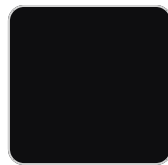

black 2002

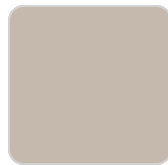

ecru 2003

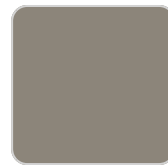

tortora 2004

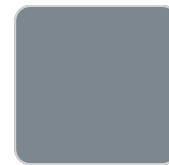

gray 2005

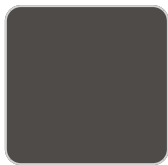

anthracite 2006

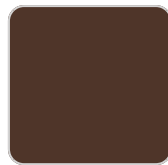

brown 2008

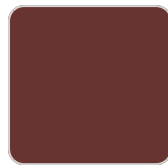

garnet 2015

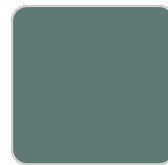

green 2016



cream 2017



blue 2018

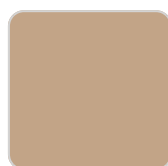

camel 2020

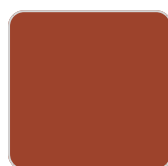

clay 2022



ecru granite

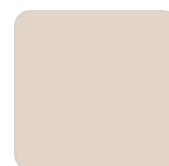

cream granite



ice 2101

Unit with internal lighting with RGBW LED technology and remote control unit for switching colors. Also controlled by DMX-1024 (wireless), enabling communication between one or more products simultaneously via the DMX transmitter (not included). There are two options to choose from: Professional XLR DMX and Home WIFI DMX. (Remote control included).

