

Milos sun lounger

by Jean-Marie Massaud

The Milos collection marks **Vondom's first collaboration with esteemed French designer Jean-Marie Massaud** and exemplifies the harmonious fusion of simplicity and functionality in exquisite garden furniture.

The exceptional design of the Milos collection was recently honored with the **Reddot Design Award 2024**, solidifying its well-deserved reputation as a pioneer of innovation and style in contemporary outdoor furniture, setting new standards for aesthetic excellence.



Info

Description

The sun lounger from the Milos collection harmoniously combines functionality and beauty. Precision manufactured, this sun lounger features a lacquered aluminium structure that ensures exceptional resistance to outdoor conditions.

Its iroko wood legs add a touch of elegance and warmth, while providing stability and a connection to nature.

Weight: 33 Kg

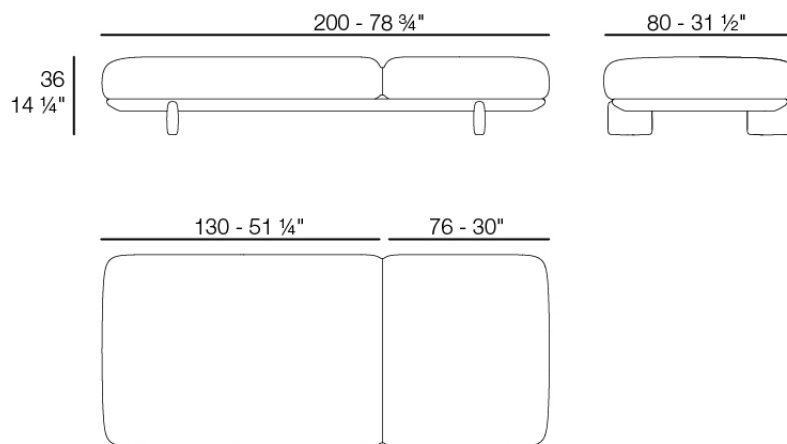

MILOS Tumbona
MILOS Sun Chaise
Ref. 70013

Finishes

finishes

Polyurethane

Ref. 70013

Furniture made of flexible polyurethane injected cold. This material possesses a high resilience and durability.

estructura

Ref. 70013AF

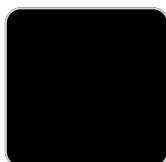

white

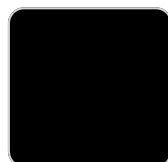

gray

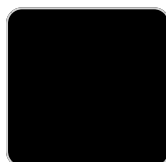

anthracite

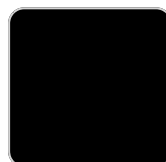

black

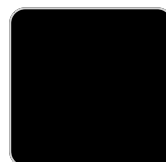

cream

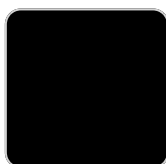

camel

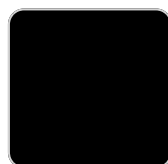

ecru

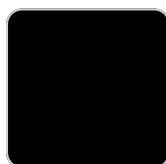

tortora

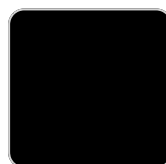

clay

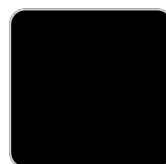

garnet

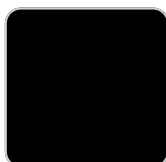

brown

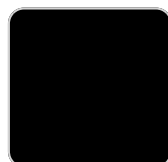

smoked

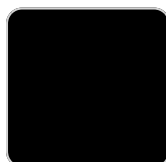

green

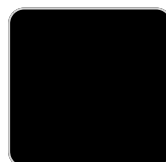

ocean

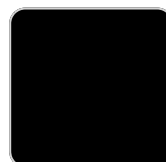

blue

fabric

GETARIA

Ref. 70013CO



oasis 10007 getaria



anthracite 10043 getaria



blue 10024 getaria



garnet 10046 getaria



aquamarine 10003 getaria



camel 10033 getaria



pearl 10006 getaria



gray 10042 getaria



ocean 10023 getaria



black 10044 getaria



oversea 10002 getaria



gallant 10025 getaria



white 10041 getaria

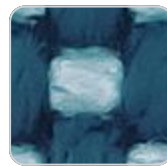

emerald 10016 getaria



green 10053 getaria



moon 10040 getaria



niord 10015 getaria



brown 10050 getaria



aphrodite 10013 getaria



tortora 10048 getaria



terra 10039 getaria



granite 10008 getaria

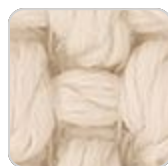

cream 10047 getaria



iceberg 10037 getaria

Group 2. Premium high density 100% acrylic fabric, available in a wide range of colors.

ZUMAIA

Ref. 70013CO

VONDOM



cream 10201 zumaia



blue 10203 zumaia



garnet 10202 zumaia



white 10200 zumaia



black 10205 zumaia



green 10204 zumaia

Group 2. Elegant 100% acrylic fabric, with a soft terry, pleasant to the touch and a unique color combination.

SUANCES

Ref. 70013CO



mustard 10305
suances



ocean 10311 suances

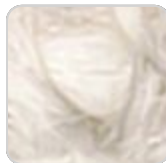

cream 10303 suances

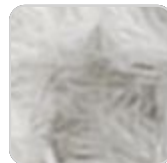

gray 10313 suances

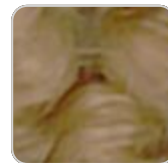

camel 10304 suances



green 10310 suances



tortora 10302 suances



blue 10312 suances



jade 10309 suances

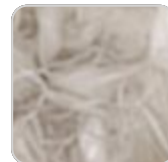

ecru 10301 suances



olive 10317 suances



brown 10308 suances

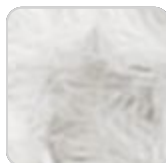

white 10300 suances



peach 10316 suances

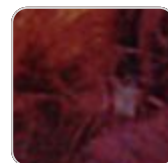

garnet 10307 suances



black 10315 suances



anthracite 10314
suances



clay 10306 suances

VONDOM

Group 2. Bocle fabric, which stands out for its warmth and softness, with matching colors that add depth and elegance.

RIBADEO Ref. 70013CO



ecru 10321 ribadeo



ocean 10331 ribadeo



cream 10323 ribadeo



mint 10337 ribadeo



jade 10329 ribadeo

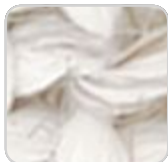

white 10320 ribadeo



green 10330 ribadeo



tortora 10322 ribadeo



olive 10336 ribadeo



brown 10328 ribadeo



peach 10335 ribadeo



garnet 10327 ribadeo



anthracite 10334
ribadeo



clay 10326 ribadeo



gray 10333 ribadeo



mustard 10325
ribadeo



blue 10332 ribadeo



camel 10324 ribadeo

Group 2. Soft fabric with marbled yarns of different thicknesses that create a rich and visually interesting texture. Its Linen look adds a touch of natural style.

LOURO Ref. 70013CO

VONDOM



peach 10355 louro



garnet 10347 louro



jade 10349 louro

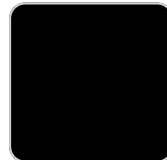

ecru



clay 10346 louro



olive 10356 louro



brown 10348 louro

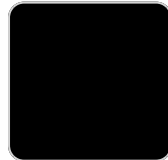

white



anthracite 10354 louro



mustard 10345 louro



gray 10353 louro



camel 10344 louro

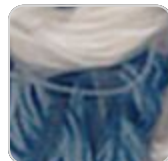

blue 10352 louro



ocean 10351 louro

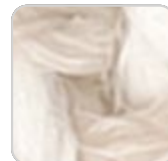

cream 10343 louro

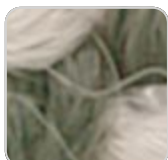

green 10350 louro



tortora 10342 louro

Group 2. Soft and versatile fabric, which presents a neutral base color that makes it easy to combine with different colors and fabrics.

Ref. 70013CO

Ambients

