

# VOXEL CHAIR

By **KARIM**



**The Voxel Chair** is the perfect conceptual architectural piece for any space. Based on the Vertex Chair, a former piece by Vondom. It presents a unique structural shape, angular and faceted, only possible due to a production by injection molding. Its weight is distributed in a balanced way due to its smartly designed shape. Its lightweight body makes it easy to transport and arrange.

**The armchair** is a minimal simple yet voluminous stackable chair that is faceted just in the perfect places for comfort, just in the right angles for hyper-strength, imbuing the correct creases for beauty, and just the few merging and converging lines for purity.

**The sun lounger** with a modern style and outdoor functionality has been born. Manufactured by injected polypropylene and reinforced with fiberglass, it's been characterized by its geometric, angled, and faceted shapes.

This sun lounger meets all hospitality needs: it's sturdy, stackable and has two wheels which makes it easier to move. It is also shaped like a skate, preventing it from sinking into the sand, so it's the ideal option for sunbathing or relaxing by the pool or by the sea. View online: <https://www.vondom.com/us/products/51033>

## Features

### Description

Made of injected polypropylene with fiber glass. Stackable. Available in several colors. Item suitable for indoor and outdoor use.

### Weight

6.5 Kg

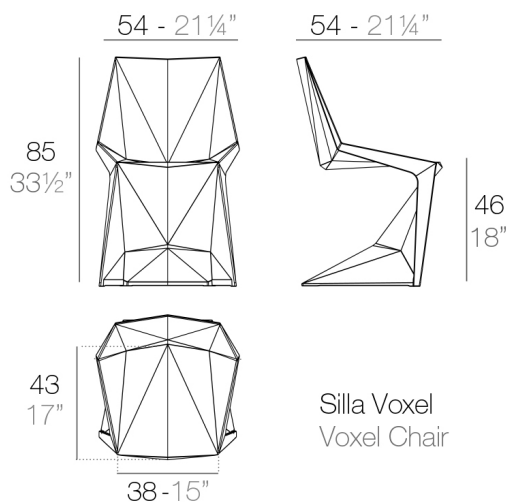

## Finishes

### BASIC PP

Ref. 51033

Available in various colors

### LACQUERED COLOR INJECTION PP

Ref. 51033F

-

COLOR	BASIC PP	LACQUERED COLOR INJECTION PP
WHITE 3102	<input type="checkbox"/>	<input type="checkbox"/>
ECRU 3111	<input type="checkbox"/>	<input type="checkbox"/>
BLACK 3126	<input type="checkbox"/>	<input type="checkbox"/>
ANTHRACITE 3106	<input type="checkbox"/>	<input checked="" type="checkbox"/>
WHITE 3101	<input type="checkbox"/>	<input type="checkbox"/>
RED 3114	<input type="checkbox"/>	<input checked="" type="checkbox"/>

BLACK 3102  
NAVY  
WHITE  
BLACK  
RED  
ECRU

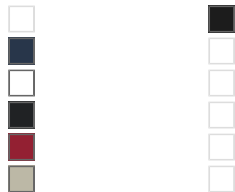

## Optional

---

### NAUTIC

Soft leather like fabric suitable for indoor and outdoor use. Standard option for upholstery.

