

SABINAS SOFÁ

By Javier Mariscal



Se inspira en las formas orgánicas fluidas, huyendo de la línea recta y de la geometría. Sus curvas aluden a las dunas, a las curvas femeninas.

Esta colección va más allá de cumplir una función, un uso y plantea una relación especial de amistad y cariño con el usuario. Como todas las colecciones del autor remiten a un código formal muy mariscaliano.

Su confort así como las características de sus materiales permiten su uso tanto en interior como en exterior.

View online: <https://www.vondom.com/es/productos/45009>

Características

Descripción

Fabricado con resina de polietileno mediante moldeo rotacional con doble pared. 100% Reciclable. Apto para exterior e interior. Disponible en varios acabados.

Peso

40 Kg

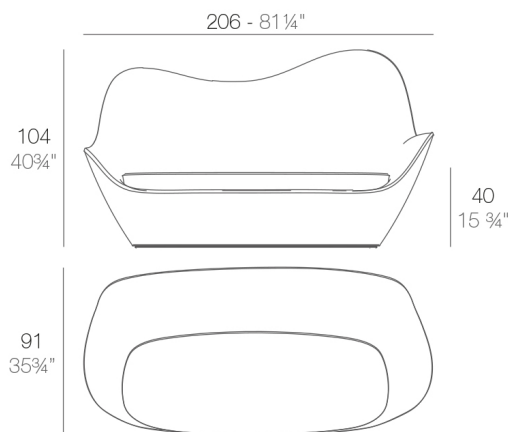

SABINAS Sofá
SABINAS Sofa

Acabados

BASIC

Ref. 45009

Resina de polietileno acabado mate.

LACADO

Ref. 45009F

Resina de polietileno con un acabado lacado brillo.

LUZ

Ref. 45009W

Con iluminación interior de color blanco mediante tecnología LED. Solo disponible en acabado hielo mate.

LED RGBW DMX

Ref. 45009D

Con iluminación interior mediante tecnología LED RGBW y mando a distancia para cambiar de color. Controlado también por DMX-1024 (wireless). Solo disponible en acabado hielo mate.

LED RGBW BATERIA

Ref. 45009Y

Con iluminación interior mediante tecnología LED RGBW, alimentado por una batería. Se incluye mando a distancia para cambiar de color y cargador. Solo disponible en acabado hielo mate.

LED RGBW DMX BATERIA

Ref. 45009DY

































































Con iluminación interior mediante tecnología LED RGBW,

LED RGBW

Ref. 45009L

Con iluminación interior mediante tecnología LED RGBW y mando a distancia para cambiar de color. Solo disponible en acabado hielo mate.

alimentado por una batería. Incluye mando a distancia para cambiar de color. Controlado también por DMX-1024 (wireless). Solo disponible en acabado hielo mate.

COLOR	BASIC	LACQUERED / LACADO	LUZ	LED RGBW DMX BATERIA
HIELO				
BLANCO				
NEGRO				
BRONCE				
ACERO				
ANTRACITA				
ROJO				
PISTACHO				
NARANJA				
KAKI				
NAVY				
TAUPE				
PLUM				
ECRU				
BEIGE				
CHAMPANY				

Optional**CREVIN**

Tejido de tapicería con aspecto natural. Apta para interior y exterior. Fácil limpieza de las manchas y el moho

SILVERTEX

Tejido vinílico apto para interior y exterior. Opción especial para los acolchados.

NAUTIC

Tejido náutico apto para interior y exterior. Opción estándar para los acolchados.

